

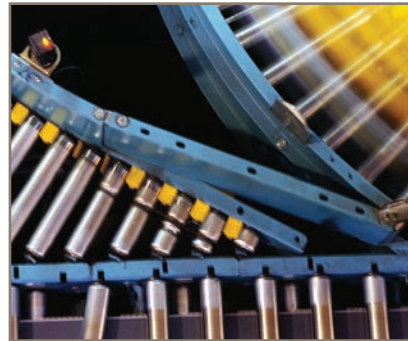

AC10 Variable Speed Drive

For Simple, Reliable Motor Control in General Purpose Applications

0.25 - 250 HP (0.2-180 kW)





AC10 IP66 Drives

WARNING - USER RESPONSIBILITY

FAILURE OR IMPROPER SELECTION OR IMPROPER USE OF THE PRODUCTS DESCRIBED HEREIN OR RELATED ITEMS CAN CAUSE DEATH, PERSONAL INJURY AND PROPERTY DAMAGE.

This document and other information from Parker Hannifin Corporation, its subsidiaries and authorized distributors provide product or system options for further investigation by users having technical expertise.

The user, through its own analysis and testing, is solely responsible for making the final selection of the system and components and assuring that all performance, endurance, maintenance, safety and warning requirements of the application are met. The user must analyze all aspects of the application, follow applicable industry standards, and follow the information concerning the product in the current product catalog and in any other materials provided from Parker or its subsidiaries or authorized distributors.

To the extent that Parker or its subsidiaries or authorized distributors provide component or system options based upon data or specifications provided by the user, the user is responsible for determining that such data and specifications are suitable and sufficient for all applications and reasonably foreseeable uses of the components or systems.

OFFER OF SALE

The items described in this document are hereby offered for sale by Parker Hannifin Corporation, its subsidiaries or its authorized distributors. This offer and its acceptance by the provisions stated in the detailed 'Offer of Sale' which is available upon request.

Overview	5
Features	6
IP20 Units.....	6
IP66 Units.....	8
Applications	10
Technical Specifications	11
Power Ratings.....	11
Electrical Characteristics	12
Environmental Characteristics.....	12
Standards and Conformance	12
Dimensions	12
Connections	15
Software	16
Accessories and Options	17
Remote Mounting Keypad.....	17
Cloning Module	17
Line Reactors.....	18
Circuit Breakers.....	19
Line Fuses.....	20
Contactors.....	21
Control Transformer	21
Dynamic Braking Resistors	22
Order Code/Part Number Table	23



AC10 IP20 Drives

Parker Hannifin

The global leader in motion and control technologies and systems

Global Partnerships Global Support

Parker is committed to helping make our customers more productive and more profitable through our global offering of motion and control products and systems. In an increasingly competitive global economy, we seek to develop customer relationships as technology partnerships. Working closely with our customers, we can ensure the best selection of technologies to suit the needs of our customers' applications.



Electromechanical Technologies for High Dynamic Performance and Precision Motion

Parker electromechanical technologies form an important part of Parker's global motion and control offering. Electromechanical systems combine high performance speed and position control with the flexibility to adapt the systems to the rapidly changing needs of the industries we serve.



Electromechanical and Drives Division Manufacturing

Parker drive products are manufactured globally to provide our customers with quality products at a competitive price point. In addition to factory-direct support, Parker provides sales assistance and local technical support through a group of dedicated sales teams and a network of authorized systems integrators, field service engineers, and technical distributors across the globe. For contact information, please refer to the Sales Offices listed on the back cover of this document or visit www.parker.com/ssdusa



Charlotte, NC



Littlehampton, UK



Wuxi, China



Chennai, India

Variable Speed Drive - AC10 Series

Overview

Description

AC10 Variable Frequency Drive is a simple, reliable and economical solution to every-day motor control applications requiring speed or torque control within the power range of 0.25 HP to 250 HP, with NEMA 4X indoor/IP66 version available through 125 HP. Having features normally only associated with higher specification drives, including sensorless vector mode, output frequency up to 590 Hz, and a full 150% overload at 0.5 Hz for 1 minute, AC10 provides an optimized solution for OEM machine builders looking for a compact, cost-effective drive without compromising on performance. The AC10 is suitable for either AC induction or permanent magnet AC motor designs.

Features

Simplicity

AC10 is designed to reduce the time and effort required to install, setup and commission through its easy to use integrated keypad. Minimal wiring requirements and two easily accessed terminal rails make AC10 fast and simple to install, having you up and running in no time at all. Auto-tuning sensorless vector mode takes AC10 beyond simple V/Hz control allowing users requiring greater dynamic speed or torque control for their application to benefit from the drives enhanced 0.5% speed and 5% torque accuracy.

Reliability

Proven technology and manufacturing techniques ensure AC10 has been engineered and built to deliver consistently outstanding levels of performance day in, day out ensuring maximum uptime and productivity. Thanks to its conformally coated PC boards, AC10 is able to withstand even the most severe class 3C3 environment which many other drives in this class would struggle with, allowing you to operate AC10 with the utmost confidence in more applications. For the ultimate in protection, IP66 rated models are available.



IP20 Model

IP66 Model



Through 20 HP

Technical Characteristics - Overview

Enclosure	IP20		NEMA 4X indoor/ IP66
Power Range	0.25-30 HP (0.2-22 kW)	40-250 HP (30-180 kW)	0.5-125 HP (0.4-90 kW)
Power Supply	220V - 240V ±15% Single Phase 220V - 240V ±15% Three Phase 380V - 480V +10%/-15% Three Phase		
Input Frequency	50/60 Hz		
Operating Temperature	0-40°C		0-50°C
Analog Inputs	2x (0-10 V, 0-5 V, 0-20 mA, 4-20 mA)		
Analog Outputs	1x (0-10 V, 0-20 mA)	2x (0-10 V, 0-20 mA)	1x (0-10 V, 0-20 mA)
Digital Inputs	5x 24 VDC	8x 24 VDC	5x 24 VDC
Digital Outputs	1x 24 VDC	2x 24 VDC	1x 24 VDC
Relay Output	1x 2 A @230 VAC		



Inverter Duty AC Induction Motors

An ideal complement to AC10, an inverter duty AC motor matched to the AC10 will provide you with a complete motor/drive package for optimal performance in your application.



Permanent Magnet AC Motors

Parker manufactures a line of compact and energy efficient permanent magnet AC motors that are compatible with the AC10.

AC10 Drives Range

One of the smallest micro-drives available and with five different frame sizes covering a power range of 0.25 HP through to 250 HP, AC10 is a low-cost, compact solution for simple AC induction motor control in a wide range of applications across a host of different industries.

IP20 Units Through 250 HP

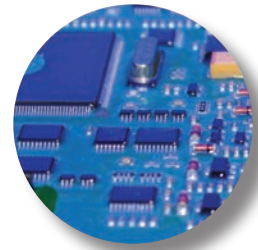

Suited to harsh environments

- Optional Internal EMC filter allows use in C3 industrial environments
- Conformal coating provides protection in arduous class 3C3 environments
- 50°C operating temperature (Derate over 40°C)
- Fan-cooled heatsink, convection cooled electronics

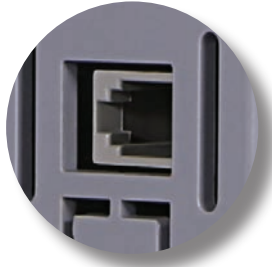

Modbus/RS485 communication

- Connection to Parker PDB drive setup and monitoring tool and AC10 Cloning Module
- Connection to PLC or other Modbus RTU/RS485 network



Flexible I/O

- Flexible digital inputs and outputs, and relay output to suit your application needs
- 1 analog output (2 on units 40HP and higher) and 2 analog inputs for connection to speed potentiometers and panel meters
- Internal dynamic brake switch as standard



Extra power when it's needed

- 150% overload for 60 seconds at 0.5 Hz to provide extra starting torque for high inertia loads
- Output power can be up-rated for operation in lower ambient temperatures





Simple or enhanced performance

- Simple V/Hz control for general energy saving applications
- Enhanced auto-tuning sensorless vector control providing higher dynamic performance for applications requiring greater speed or torque accuracy



All at the touch of a button

- Standard ergonomic keypad providing full access to all drive functions
- 4 LEDs provide instant indication of drive status
- Remote mountable keypad option for ease of setup and operation
- Simple out of the box operation thanks to integrated macros and quick start guide



IP20 Keypad

Control at your fingertips

Every AC10 comes complete with an ergonomic operator keypad as standard, featuring LED drive status indicators, a display and a tactile membrane style keypad.

In addition to displaying operating status and running information, the display is also used to access drive configuration parameters which can be quickly and easily changed via the keypad. A three level menu structure ensures that configuration is simple and organized.

The keypad can also be used to take local control of the motor to start, stop, increase or decrease motor speed.

An optional remote mounting keypad is also available for IP20 units, providing the same functionality as the drive mounted keypad.

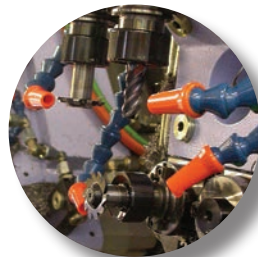

High Speed Operation

- Up to 590 Hz output for high speed operations such as spindles, centrifuges, mixers etc.

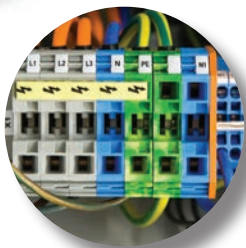

Choice of operating voltages

- 230V single and three phase input up to 20 HP
- 480V three phase input from 0.25 HP through 250 HP

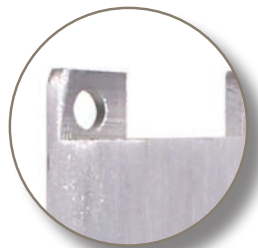

Compact Dimensions

- When compared to other micro drives of similar functionality, AC10 is noticeably more compact reducing cabinet space and freeing up valuable floor space.

IP66 Units Through 125 HP

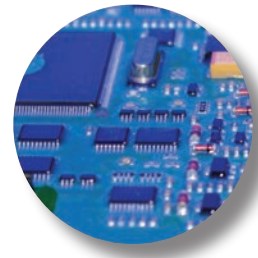

AC10 IP66/NEMA4X

IP66/NEMA 4X (indoor) apply to IEC standard 60529-2004 and NEMA standards, and assess the capability of an enclosure to resist specific environmental conditions. IP66/NEMA 4X protection represents dust tight performance as well as the ability to withstand powerful water jets from all directions. Parker's AC10 IP66/NEMA 4X series offers all the great benefits of the AC10 series drives but with added environmental protection.



Suited to harsh, wet, and dusty environments

- Robust NEMA 4X indoor/IP66 enclosure for direct mounting in dusty or moist environments
- Optional Internal EMC filter allows use in C3 industrial environments
- Conformal coating provides protection in arduous class 3C3 environments
- 50°C operating temperature

Flexible Connections

- Flexible digital inputs and outputs, and relay output to suit your application needs
- Internal dynamic brake switch as standard
- Easy user access with removable "gland plate"
- Clone module connection



Modbus/RS485 communication

- Connection to Parker PDB drive setup and monitoring tool
- Connection to PLC or other Modbus RTU/RS485 network



Extra power when it's needed

- 150 % overload for 60 seconds at 0.5 Hz to provide extra starting torque for high inertia loads



Through 20 HP



Simple or enhanced performance

- Simple V/Hz control for general energy saving applications
- Enhanced auto-tuning sensorless vector control providing higher dynamic performance for applications requiring greater speed or torque accuracy



All at the touch of a button

- NEMA 4/IP66 ergonomic keypad providing full access to all drive functions
- Simple out of the box operation thanks to integrated macros and quick start guide



IP66 Keypad

Control at your fingertips

AC10 comes complete with an ergonomic operator keypad as standard, featuring LED drive status indicators, a display and a tactile membrane style keypad.

In addition to displaying operating status and running information, the display is also used to access drive configuration parameters which can be quickly and easily changed via the keypad. A three level menu structure ensures that configuration is simple and organized.

The keypad can also be used to take local control of the motor to start, stop, increase or decrease motor speed.

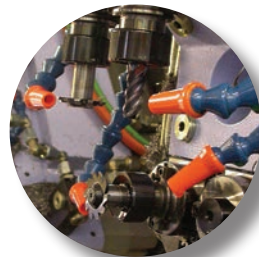

High Speed Operation

- Up to 590 Hz output for high speed operations such as spindles, centrifuges, mixers etc.

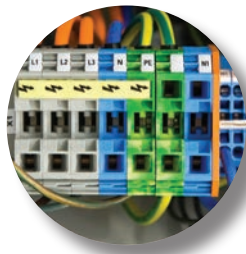

Choice of operating voltages

- 230V single and three phase input up to 3 HP
- 480V three phase input from 0.25 HP through 125 HP

Applications

AC10 provides a simple approach to general purpose industrial motor control applications across a wide range of industries, giving users the benefits of the inherent energy-saving properties of using a variable speed drive, as well as the improved reliability and extended service life benefits associated with smoother starting and stopping of regularly cycling loads.

Making use of pre-defined control logic, **Application Macros** enable users to quickly configure the AC10 for control of one of a number of pre-defined functions. Information is presented to the user in a template format which can then be simply and easily populated with the specific details of the application.

Typical applications for AC10 include...

- Conveyors
- Centrifuges
- Fans
- Mixers
- Packaging Machines
- Textile Machines
- Pumps
- Strapping Machines
- Labeling Machines
- Industrial Washing Machines
- Machine Tool Spindles
- Food and Beverage



Conveyors



Fans



Mixers

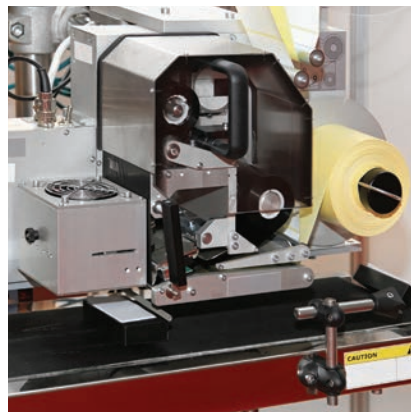

Packaging Machines

AC10 Standard Application Macros include...



BASIC SPEED CONTROL

Set speed and voltage or current with start/stop direction control

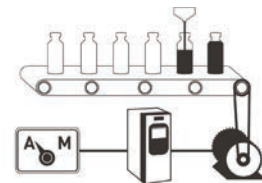

AUTOMATIC/MANUAL CONTROL

Set to run with local speed setting or external reference

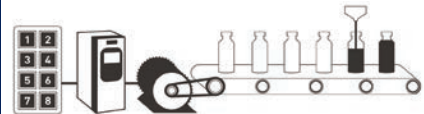

PRESET SPEED CONTROL

Select up to 8 pre-programmed speeds using digital inputs

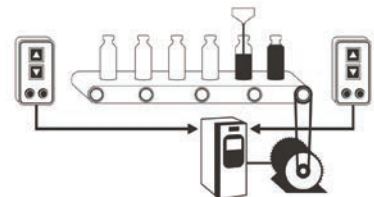

RAISE/LOWER

Increase or reduce speed using digital inputs



Speed Setpoint Pressure or Volume Feedback

PID CONTROL

Control the pressure, flow, temperature or any process variable

Technical Specifications

Power Ratings - IP20



230V Single Phase Input				
Part Number	Nominal Power		Output Current [A]	Frame Size
	HP	kW		
10G-11-0015-BN	0.25	0.2	1.4	1
10G-11-0025-BN	0.5	0.4	2.4	1
10G-11-0035-BN	0.75	0.55	3.3	1
10G-11-0045-BN	1	0.75	4.3	1
10G-12-0050-BN	1.5	1.1	4.8	2
10G-12-0070-BN	2	1.5	6.7	2
10G-12-0100-BN	3	2.2	9.6	2

230V Three Phase Input				
Part Number	Nominal Power		Output Current [A]	Frame Size
	HP	kW		
10G-31-0015-BN	0.25	0.2	1.4	1
10G-31-0025-BN	0.5	0.4	2.4	1
10G-31-0035-BN	0.75	0.55	3.3	1
10G-31-0045-BN	1	0.75	4.3	1
10G-32-0050-BN	1.5	1.1	4.8	2
10G-32-0070-BN	2	1.5	6.7	2
10G-32-0100-BN	3	2.2	9.6	2
10G-33-0170-BN	5	4	17	3
10G-34-0210-BN	7.5	5.5	21	4
10G-35-0300-BN	10	7.5	30	5
10G-35-0400-BN	15	11	40	5
10G-36-0500-BN	20	15	55	6

480V Three Phase Input				
Part Number	Nominal Power		Output Current [A]	Frame Size
	HP	kW		
10G-41-0006-BN	0.25	0.2	0.5	1
10G-41-0010-BN	0.5	0.4	0.9	1
10G-41-0015-BN	0.75	0.55	1.3	1
10G-42-0020-BN	1	0.75	1.7	2
10G-42-0030-BN	1.5	1.1	2.6	2
10G-42-0040-BN	2	1.5	3.5	2
10G-42-0065-BN	3	2.2	5.7	2
10G-43-0090-BN	5	4	7.8	3
10G-43-0120-BN	7.5	5.5	10	3
10G-44-0170-BN	10	7.5	15	4
10G-44-0230-BN	15	11	20	4
10G-45-0320-BN	20	15	28	5
10G-45-0380-BN	25	18.5	33	5
10G-45-0440-BN	30	22	38	5
10G-46-0600-BN	40	30	52	6
10G-47-0750-BN	50	37	65	7
10G-47-0900-BN	60	45	78	7
10G-48-1100-BN	75	55	96	8
10G-48-1500-BN	100	75	130	8
10G-49-1800-BN	125	90	157	9
10G-49-2200-BN	150	110	191	9
10G-410-2650-BN	200	132	230	10
10G-411-3200-BN	225	160	278	11
10G-411-3600-BN	250	180	313	11

Power Ratings - IP66



230V Single Phase Input				
Part Number	Nominal Power		Output Current [A]	Frame Size
	HP	kW		
16G-11-0025-BN	0.5	0.4	2.4	1
16G-11-0045-BN	1	0.75	4.3	1
16G-11-0070-BN	2	1.5	6.7	1
16G-11-0100-BN	3	2.2	9.6	1

230V Three Phase Input				
Part Number	Nominal Power		Output Current [A]	Frame Size
	HP	kW		
16G-31-0025-BN	0.5	0.4	2.4	1
16G-31-0045-BN	1	0.75	4.3	1
16G-31-0070-BN	2	1.5	6.7	1
16G-31-0100-BN	3	2.2	9.6	1

480V Three Phase Input				
Part Number	Nominal Power		Output Current [A]	Frame Size
	HP	kW		
16G-41-0020-BN	1	0.75	1.7	1
16G-41-0040-BN	2	1.5	3.5	1
16G-41-0065-BN	2	2.2	5.7	1
16G-41-0090-BN	5	4	7.8	1
16G-42-0120-BN	7.5	5.5	10	2
16G-42-0170-BN	10	7.5	15	2
16G-43-0230-BN	15	11	20	3
16G-43-0320-BN	20	15	28	3
16G-44-0380-BN	25	18.5	33	4
16G-44-0440-BN	30	22	38	4
16G-44-0600-BN	40	30	52	4
16G-45-0750-BN	50	37	65	5
16G-45-0900-BN	60	45	78	5
16G-45-1100-BN	75	55	96	5
16G-46-1500-BN	100	75	130	6
16G-46-1800-BN	125	90	157	6

UL applies to IP66 units through 20 HP

Electrical Specifications

Power Supply	1 ph 220V-240V ±15%, 3 ph 220V-240V ±15% 3 ph 380V-480V +10%/-15%
Rated Input Frequency	50/60 Hz
Maximum Switching Frequency	10 kHz without derating
Overload	150% of rated current for 60 seconds, 200% of rated current for 2 seconds
Output Frequency	0.5-590 Hz
Digital Resolution	0.01 Hz
Switching Frequency	2-10 kHz selectable
Control Mode	Volts/Hertz or Sensorless Vector (SLV) Mode
Earth Leakage Current	>10 mA (all models)
SCCR	100 kA with recommended line fuses

Environmental Characteristics

Temperature Range	Operating Temperature: 0-50°C, (derate above 40°C - IP20 only)
Humidity	Operating humidity: Below 90% Relative Humidity, non-condensing (95% for IP66)
Vibration	Below 0.5 g
Altitude	1000 m ASL
Protection Degree	IP20 and IP66/NEMA 4X indoor models
Chemically Active Substances	For the standard product, compliance with EN60271-3-3 is Class 3C3

Standards and Conformance

Overvoltage Category	Overvoltage category III (numeral defining an impulse withstand level)
EMC Compatibility	Meets the requirements of IEC/EN61800-3 : 2004 “Adjustable speed electrical power drive systems – Part 3”
Certifications	UL Listed. UL508C and CSA 22.2 - All IP20 units and IP66 units through 20 HP

Dimensions [in/mm]

IP20 Frame	Height (H)	Width (W)	Depth (D)	Weight [lb/kg]
1	5.43/138	3.15/80	5.31/135	2.76/1.25
2	7.09/180	4.17/106	5.91/150	3.88/1.76
3	9.25/235	5.43/138	5.98/152	6.53/2.96
4	10.43/265	6.14/156	6.69/170	10.80/4.9
5	13.39/340	8.07/205	7.71/196	16.53/7.5
6	17.16/435	10.43/265	9.25/235	37.48/17
7	18.90/480	12.40/315	9.21/234	55.12/25
8	21.85/555	14.17/360	10.43/265	88.19/40
9	24.80/630	16.14/410	11.81/300	121.25/55
10	30.12/765	20.32/516	12.83/326	207.24/94
11	35.83/910	22.05/560	13.46/342	264.56/120

See IP20 outline drawings on page 13

IP66 Frame	Height (H)	Width (W)	Depth (D)	Weight [lb/kg]
1	16.22/412	7.87/200	7.80/198	17.6/8.0
2	16.46/418	9.53/242	7.80/198	22.1/10.0
3	18.54/471	9.53/242	8.98/228	28.7/13.0
4	25.59/650	9.53/242	12.74/323.5	61.7/28.0
5	26.77/680	12.13/308	14.90/378.5	86.0/39.0
6	30.32/770	14.57/370	15.89/403.5	147.7/67.0

See IP66 outline drawings on page 14

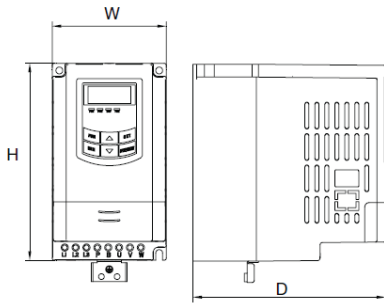

Frame 1 (IP20)

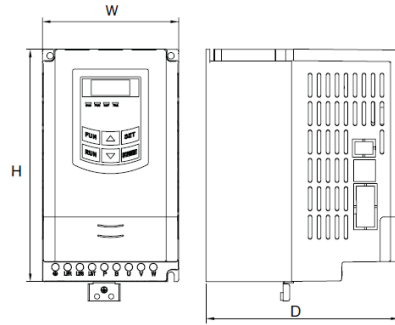

Frame 2 (IP20)

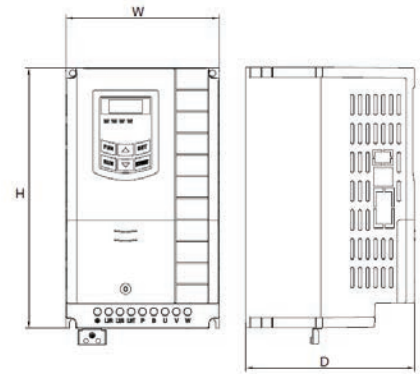

Frame 3 (IP20)

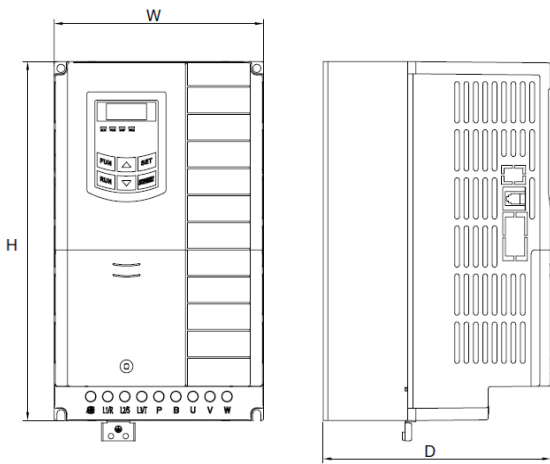

Frame 4 (IP20)

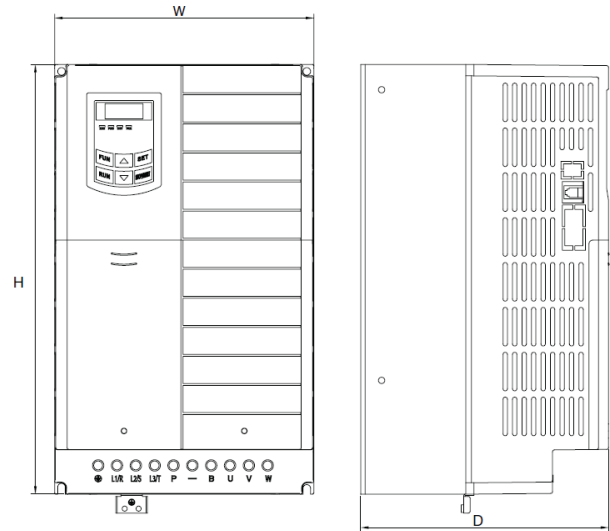

Frame 5 (IP20)

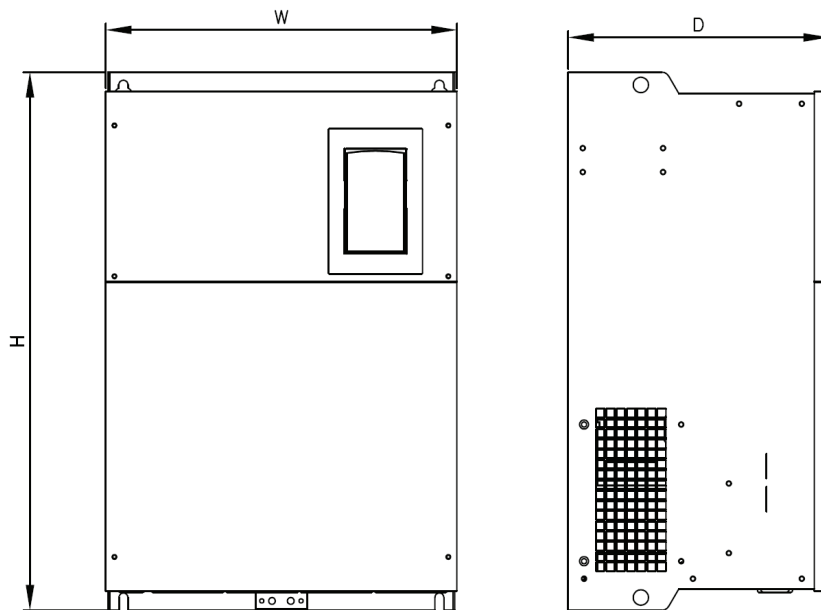

Frame 6, 7, 8, 9, 10, 11 (IP20)

Variable Speed Drive - AC10
Dimensions

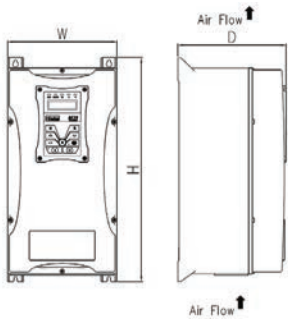

Frame 1 (IP66)

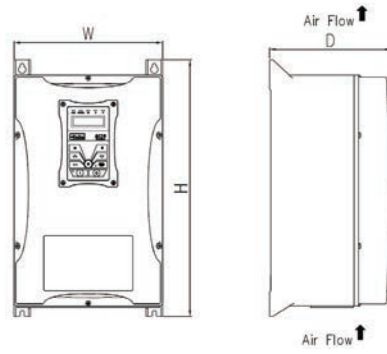

Frame 2 (IP66)

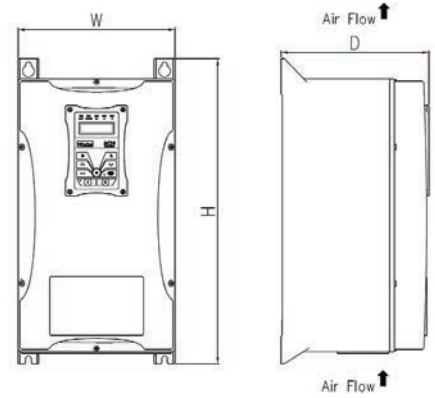

Frame 3 (IP66)

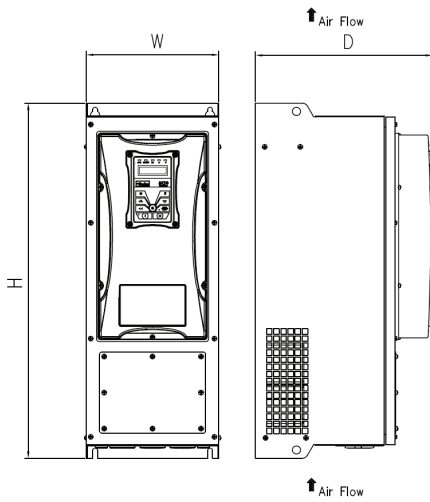

Frame 4 (IP66)

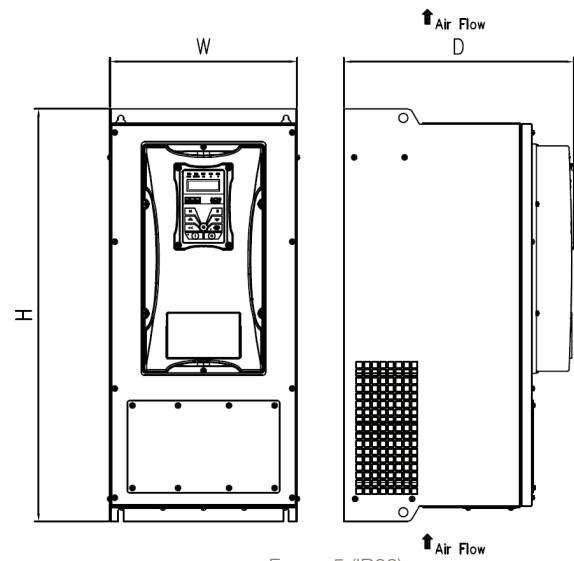

Frame 5 (IP66)

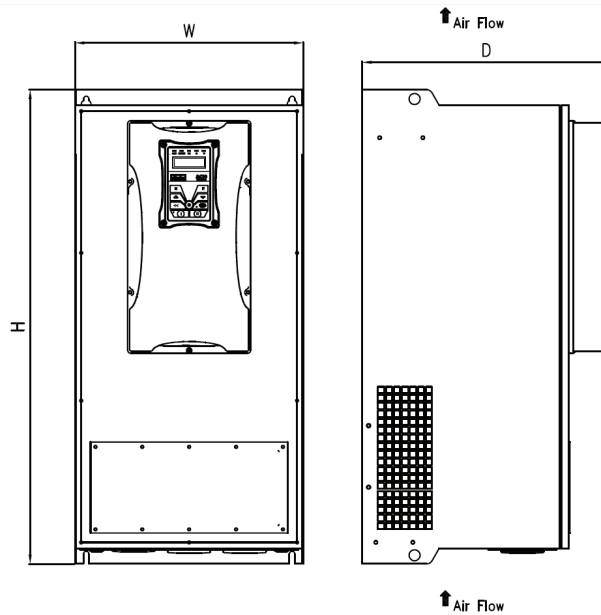

Frame 6 (IP66)

Connections

Power Terminals	Description
L1/R	Single or three phase input L1
L2/S	Single or three phase input L2
L3/T	Three phase input L3
P	Braking Resistor
B	Braking Resistor
U	Motor Output phase 1/U
V	Motor Output phase 2/V
W	Motor Output phase 3/W

Control Terminals	Description
TA	Alarm N/O relay contact, 5A, 24V rated
TB	Alarm N/C relay contact, 5A, 24V rated
TC	Drive Alarm common
DO1	Digital Output 1
DO2	Digital Output 2 (Frames 6-11)
24V	24 VDC Power output (max 50 mA)
CM	0 V DC common
DI1	Digital Input 1
DI2	Digital Input 2
DI3	Digital Input 3
DI4	Digital Input 4
DI5	Digital Input 5
DI6	Digital Input 6 (Frames 6-11)
DI7	Digital Input 7 (Frames 6-11)
DI8	Digital Input 8 (Frames 6-11)
10V	10 V Reference supply (max 20 mA)
AI1	Analog input 1
AI2	Analog input 2
GND	Power Supply 0V
AO1	Analog Output 1
AO2	Analog Output 2 (Frame 6-11)
A+	RS485 Channel A
B-	RS485 Channel B

- Analog Input 1: (0-10 V)
- Analog Input 2: (0-10 V, 0-20 mA)
- Analog Outputs: (0-10 V, 0-20 mA)
- Digital Inputs: Nominal 24 VDC
- Digital Output: Nominal 24 VDC
- Relay Output: Volt free (dry) contact, 2A@230 VAC max

This illustration is for reference only, and may not show the connections for your specific drive. Please refer to the specific product installation manual for detailed connection diagram.

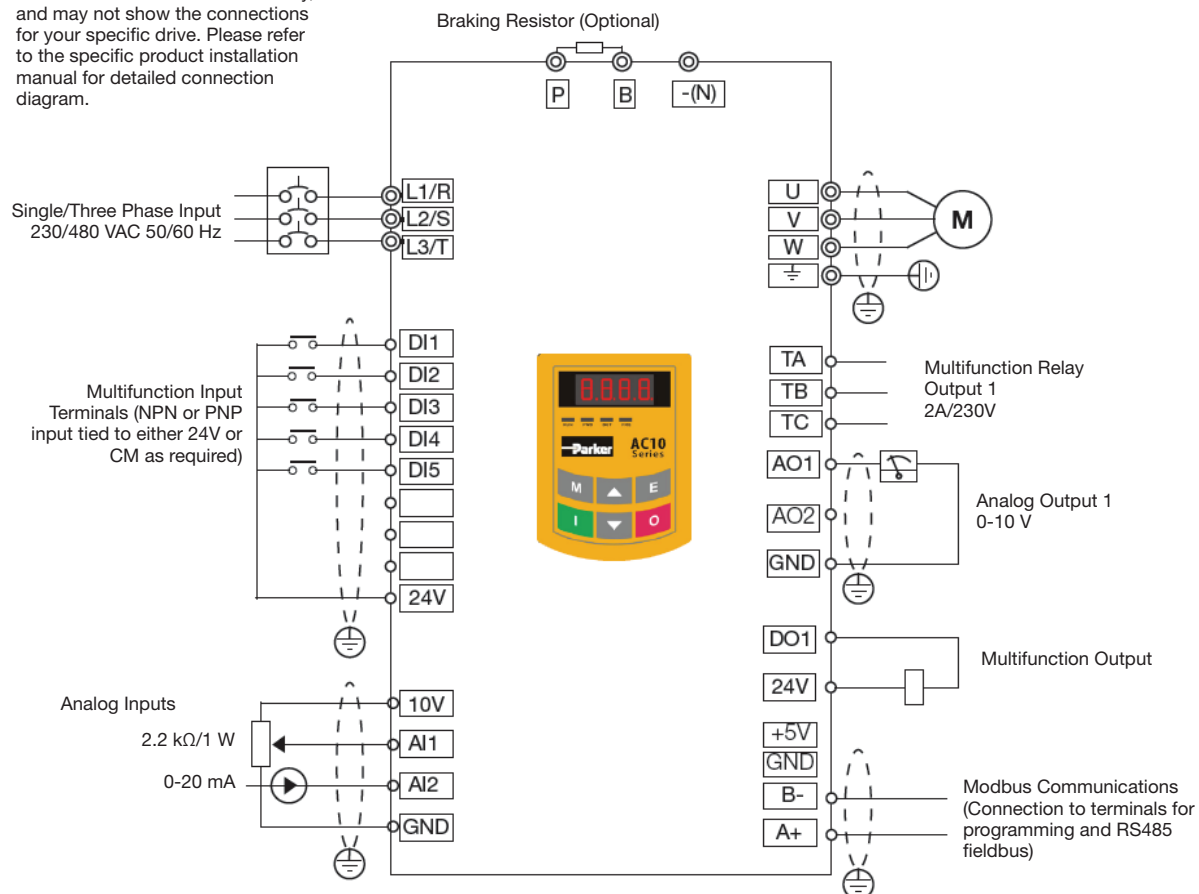

Software

Parker Drive System Explorer (DSE) Lite

Parker drive configuration software Drive System Explorer (DSE) Lite is an easy to use drive configuration software package, designed to make programming your application as simple as possible without compromising on functionality.

DSE Lite is based around a straightforward block programming and an intuitive user interface which supports user-defined configurations and offers real-time monitoring and charting. DSE Lite allows the user to create, parameterize and configure user defined applications as well as parameterize and connect fixed motor control blocks.

It is available free of charge to download from www.parker.com/ssdusa/software

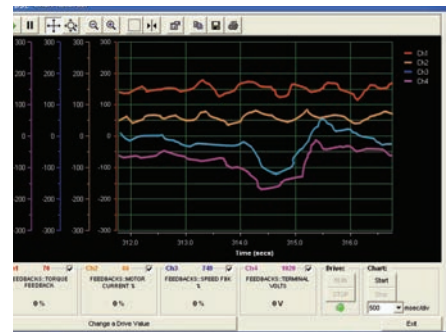
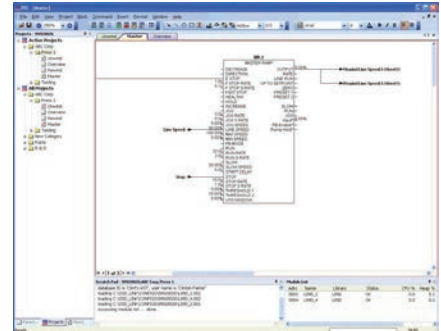

Configuration and Monitoring Software - Parker Drive Basic (PDB)

PDB is a monitoring and configuration software tool provided free of charge with the AC10, and updates will be available as released on our website. Connecting to the AC10 over Modbus, Parker Drive Basic enables users to import, modify and export drive parameters as well as providing a convenient means of starting, stopping and monitoring the operation of the drive.

Note: an RS232/RS485 adapter is required to enable connection between PC and drive.

To download PDB software, please visit www.parker.com/ssdusa/software

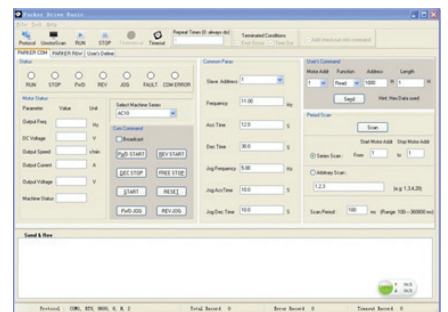
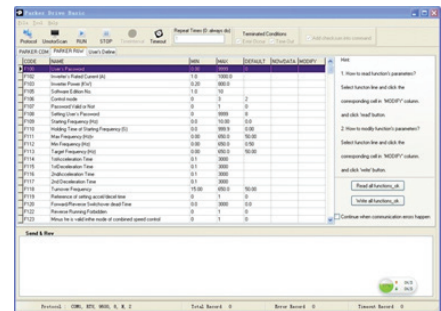

Accessories and Options

Remote Mounting Keypad - IP20

The remote mounting keypad (IP20) can be mounted away from the drive, such as on the door of an electrical enclosure, allowing users to configure, operate and monitor the drive without having to access the drive directly. The remote keypad provides an alternative offering the same functionality as the drive mounted keypad but can be connected to the drive via a 1.5 m cable plugged into the port on the left hand side of the drive.

Order Code	Description
1001-00-00	Remote Keypad (AC10 IP20 only)
1001-01-00	Extension cable (1.5m)



Remote Mounting Keypad - IP66

The remote mounting keypad (IP66) can be mounted away from the IP66 drive, allowing users to configure, operate and monitor the drive without having to access the drive directly. The remote keypad provides an alternative offering the same functionality as the drive mounted keypad but can be connected to the drive via a 1.5 m cable with IP66 plugs. For use with IP66 drives only.

Order Code	Description
1601-00-00	Remote Keypad (AC10 IP66 only)
1602-01-00	Extension cable (1.5m)



Cloning Module

Allows users to copy applications between drives and upload/download parameter sets between drive and PDB software.

Order Code	Description
1002-00-00	Cloning Module



Power Disconnect

Available on IP66 units through 20 HP, this option provides a means to disconnect AC power from the drive. It includes a lock-out enabled handle.

Order Code	Description
Consult factory	Power Disconnect



Accessories and Options

Three Phase Line Reactor

Line reactors can help limit input harmonics and act as a current limiting device. They help protect the AC10 from potentially harmful power line disturbances.

AC10 (IP20) Part Number	AC10 (IP66) Part Number	HP (230V)	Line Reactor Part Number	Inductance [mH]
10G-31-0015-BN	-	0.25	CO473957U016	6.9
10G-31-0025-BN	16G-31-0025-BN	0.5	CO473957U021	5.3
10G-31-0035-BN	-	0.75	CO473957U034	3.2
10G-31-0045-BN	16G-31-0045-BN	1	CO473957U048	2.3
10G-32-0050-BN	-	1.5	CO473958U110	2.1
10G-32-0070-BN	16G-31-0070-BN	2	CO473957U076	1.5
10G-32-0100-BN	16G-31-0100-BN	3	CO473957U110	1
10G-33-0170-BN	-	5	CO353012	0.8
10G-34-0210-BN	-	7.5	CO353013	0.5
10G-35-0300-BN	-	10	CO353014	0.4
10G-35-0400-BN	-	15	CO353015	0.3
10G-36-0500-BN	-	20	CO353016	0.25

Note: Accessories and options are not IP66 rated.

AC10 (IP20) Part Number	AC10 (IP66) Part Number	HP (480V)	Line Reactor Part Number	Inductance [mH]
10G-41-0006-BN	-	0.25	CO473958U010	33
10G-41-0010-BN	-	.5	CO473958U011	21
10G-41-0015-BN	-	.75	CO473958U016	14
10G-42-0020-BN	16G-41-0020-BN	1	CO473958U021	11
10G-42-0030-BN	-	1.5	CO473958U047	7.7
10G-42-0040-BN	16G-41-0040-BN	2	CO473958U034	6.8
10G-42-0065-BN	16G-41-0065-BN	3	CO473958U048	4.8
10G-43-0090-BN	16G-41-0090-BN	5	CO473958U076	3
10G-43-0120-BN	16G-42-0120-BN	7.5	CO473958U110	2.1
10G-44-0170-BN	16G-42-0170-BN	10	CO473958U140	1.6
10G-44-0230-BN	16G-43-0230-BN	15	CO473958U210	1.1
10G-45-0320-BN	16G-43-0320-BN	20	CO473958U280	0.82
10G-45-0380-BN	16G-44-0380-BN	25	CO473958U350	0.71
10G-45-0440-BN	16G-44-0440-BN	30	CO473958U460	0.55
10G-46-0600-BN	16G-44-0600-BN	40	CO473958U650	0.36
10G-47-0750-BN	16G-45-0750-BN	50	CO473958U650	0.36
10G-47-0900-BN	16G-45-0900-BN	60	CO473958U830	0.29
10G-48-1100-BN	16G-45-1100-BN	75	CO473958U1K0	0.23
10G-48-1500-BN	16G-46-1500-BN	100	CO473958U1K3	0.18
10G-49-1800-BN	16G-46-1800-BN	125	CO473958U1K6	0.155
10G-49-2200-BN	-	150	CO473958U2K0	0.115
10G-410-2650-BN	-	200	CO473958U2K5	0.095
10G-411-3200-BN	-	225	CO473958U3K2	0.07
10G-411-3600-BN	-	250	CO473958U4K1	0.066

Accessories and Options

Circuit Breakers

AC10 (IP20) Part Number	AC10 (IP66) Part Number	HP (230V Single Phase)	Circuit Breaker Part Number
10G-11-0015-BN		0.25	DC473952U010
10G-11-0025-BN	16G-11-0025-BN	0.5	
10G-11-0035-BN		0.75	DC473952U015
10G-11-0045-BN	16G-11-0045-BN	1	DC473952U025
10G-12-0050-BN		1.5	
10G-12-0070-BN	16G-11-0070-BN	2	DC473952U040
10G-12-0100-BN	16G-11-0100-BN	3	

Note: Accessories and options are not IP66 rated.

Two-pole breaker rated at 240V

AC10 (IP20) Part Number	AC10 (IP66) Part Number	HP (230V 3 Phase)	Circuit Breaker Part Number
10G-31-0015-BN	-	0.25	DC472106U015
10G-31-0025-BN	16G-31-0025-BN	0.5	
10G-31-0035-BN	-	0.75	
10G-31-0045-BN	16G-31-0045-BN	1	
10G-32-0050-BN	-	1.5	DC472106U020
10G-32-0070-BN	16G-31-0070-BN	2	
10G-32-0100-BN	16G-31-0100-BN	3	DC472106U030
10G-33-0170-BN	-	5	
10G-34-0210-BN	-	7.5	DC472106U050
10G-35-0300-BN	-	10	DC472106U080
10G-35-0400-BN	-	15	
10G-36-0500-BN	-	20	DC472106U100
AC10 (IP20) Part Number	AC10 (IP66) Part Number	HP (480V)	Circuit Breaker Part Number
10G-41-0006-BN	-	0.25	DC472106U015
10G-41-0010-BN	-	0.5	
10G-41-0015-BN	-	0.75	
10G-42-0020-BN	16G-41-0020-BN	1	
10G-42-0030-BN	-	1.5	DC472106U020
10G-42-0040-BN	16G-41-0040-BN	2	
10G-42-0065-BN	16G-41-0065-BN	3	DC472106U030
10G-43-0090-BN	16G-41-0090-BN	5	
10G-43-0120-BN	16G-42-0120-BN	7.5	DC472106U050
10G-44-0170-BN	16G-42-0170-BN	10	
10G-44-0230-BN	16G-43-0230-BN	15	DC472106U070
10G-45-0320-BN	16G-43-0320-BN	20	DC472106U080
10G-45-0380-BN	16G-44-0380-BN	25	
10G-45-0440-BN	16G-44-0440-BN	30	DC472106U100
10G-46-0600-BN	16G-44-0600-BN	40	
10G-47-0750-BN	16G-45-0750-BN	50	DC472106U100
10G-47-0900-BN	16G-45-0900-BN	60	DC472106U125
10G-48-1100-BN	16G-45-1100-BN	75	DC472108U150
10G-48-1500-BN	16G-46-1500-BN	100	DC472108U200
10G-49-1800-BN	16G-46-1800-BN	125	DC472108U250
10G-49-2200-BN	-	150	DC472109U300
10G-410-2650-BN	-	200	DC472109U350
10G-411-3200-BN	-	225	DC472109U400
10G-411-3600-BN	-	250	DC472110U500

Accessories and Options

Fuse Kits Fuse kits provide protection on the AC line side, and include fuses and fuse blocks. Provided loose for panel mounting.

AC10 (IP20) Part Number	AC10 (IP66) Part Number	HP (230V single phase)	Fuse Kit Part Number
10G-11-0015-BN	-	0.25	LA473950U015
10G-11-0025-BN	16G-11-0025-BN	0.5	
10G-11-0035-BN	-	0.75	
10G-11-0045-BN	16G-11-0045-BN	1	LA473950U025
10G-12-0050-BN	-	1.5	
10G-12-0070-BN	16G-11-0070-BN	2	
10G-12-0100-BN	16G-11-0100-BN	3	

Note: Accessories and options are not IP66 rated.



AC10 (IP20) Part Number	AC10 (IP66) Part Number	HP (230V 3 phase)	Fuse Kit Part Number
10G-31-0015-BN	-	0.25	LA473951U015
10G-31-0025-BN	16G-31-0025-BN	0.5	
10G-31-0035-BN	-	0.75	
10G-31-0045-BN	16G-31-0045-BN	1	LA473951U025
10G-32-0050-BN	-	1.5	
10G-32-0070-BN	16G-31-0070-BN	2	
10G-32-0100-BN	16G-31-0100-BN	3	
10G-33-0170-BN	-	5	LA473951U045
10G-34-0210-BN	-	7.5	LA473951U060
10G-35-0300-BN	-	10	LA473951U080
10G-35-0400-BN	-	15	LA473951U100
10G-36-0500-BN	-	20	LA473951U125



AC10 (IP20) Part Number	AC10 (IP66) Part Number	HP (480V)	Fuse Kit Part Number
10G-41-0006-BN	-	0.25	LA473951U006
10G-41-0010-BN	-	0.5	
10G-41-0015-BN	-	0.75	
10G-42-0020-BN	16G-41-0020-BN	1	LA473951U015
10G-42-0030-BN	-	1.5	
10G-42-0040-BN	16G-41-0040-BN	2	
10G-42-0065-BN	16G-41-0065-BN	3	
10G-43-0090-BN	16G-41-0090-BN	5	LA473951U030
10G-43-0120-BN	16G-42-0120-BN	7.5	
10G-44-0170-BN	16G-42-0170-BN	10	LA473951U045
10G-44-0230-BN	16G-43-0230-BN	15	LA473951U060
10G-45-0320-BN	16G-43-0320-BN	20	LA473951U080
10G-45-0380-BN	16G-44-0380-BN	25	LA473951U090
10G-45-0440-BN	16G-44-0440-BN	30	LA473951U100
10G-46-0600-BN	16G-44-0600-BN	40	LA473951U125
10G-47-0750-BN	16G-45-0750-BN	50	LA473951U150
10G-47-0900-BN	16G-45-0900-BN	60	LA473951U200
10G-48-1100-BN	16G-45-1100-BN	75	
10G-48-1500-BN	16G-46-1500-BN	100	LA473951U300
10G-49-1800-BN	16G-46-1800-BN	125	LA473951U350
10G-49-2200-BN	-	150	LA473951U400
10G-410-2650-BN	-	200	LA473951U500
10G-411-3200-BN	-	225	LA473951U600
10G-411-3600-BN	-	250	



Accessories and Options

Contactors

Rated 690VAC, 3-pole design. Provided loose for panel mounting.

AC10 (IP20) Part Number	AC10 (IP66) Part Number	HP Rating	Contactors Part Number
10G-1X-XXXX-BN	16G-1X-XXXX-BN	All	DB473959U020
10G-31-XXXX-BN	16G-31-XXXX-BN	All	DB473959U020
10G-41-0006-BN	-	0.25	DB473959U020
10G-41-0010-BN	-	0.5	
10G-41-0015-BN	-	0.75	
10G-42-0020-BN	16G-41-0020-BN	1	
10G-42-0030-BN	-	1.5	
10G-42-0040-BN	16G-41-0040-BN	2	
10G-42-0065-BN	16G-41-0065-BN	3	
10G-43-0090-BN	16G-41-0090-BN	5	
10G-43-0120-BN	16G-42-0120-BN	7.5	
10G-44-0170-BN	16G-42-0170-BN	10	
10G-44-0230-BN	16G-43-0230-BN	15	
10G-45-0320-BN	16G-43-0320-BN	20	DB473115U040
10G-45-0380-BN	16G-44-0380-BN	25	
10G-45-0440-BN	16G-44-0440-BN	30	DB473115U070
10G-46-0600-BN	16G-44-0600-BN	40	
10G-47-0750-BN	16G-45-0750-BN	50	DB473115U100
10G-47-0900-BN	16G-45-0900-BN	60	
10G-48-1100-BN	16G-45-1100-BN	75	DB473115U135
10G-48-1500-BN	16G-46-1500-BN	100	
10G-49-1800-BN	16G-46-1800-BN	125	DB473115U160
10G-49-2200-BN	-	150	
10G-410-2650-BN	-	200	DB473115U275
10G-411-3200-BN	-	225	
10G-411-3600-BN	-	250	DB473115U350

Note: Accessories and options are not IP66 rated.

Control Transformer

Provides 120 volt single phase from 230/460 volt line. Transformer kit includes primary and secondary fuses. Select based on HP rating of drive.

AC10 Ratings	Control Transformer Part Number	Description	Spare primary fuse	Spare secondary fuse
All AC10 from 0.25-125 HP	LA473961U0150	Control transformer kit - 150 VA	CH352006U015	CH352124U025
All AC10 from 150-250 HP	LA473961U0250	Control transformer kit - 250 VA	CH352006U030	CH352124U040

Note: Accessories and options are not IP66 rated.

Dynamic Braking Resistors

During deceleration, or with an over-hauling load, the motor acts as a generator. Energy flows back from the motor into the DC link capacitors within the drive, causing their voltage to rise. If this voltage exceeds a maximum value, the drive will trip to protect the capacitors and internal power devices. To increase the drive's dynamic braking capability, high power resistor(s), connected across the DC link, allow the dissipation of this excess energy for short term stoppage or braking.

Note: Accessories and options are not IP66 rated.

AC10 (IP20) Part Number	AC10 (IP66) Part Number	HP Rating	DB Kit Part Number	Resistance [Ohms]	Power [W]
10G-11-XXXX-BN	16G-11-XXXX-BN	All	LA471357	100	200
10G-31-0015-BN	-	0.25	LA471357	100	200
10G-31-0025-BN	16G-31-0025-BN	0.5			
10G-31-0035-BN	-	0.75			
10G-31-0045-BN	16G-31-0045-BN	1			
10G-32-0050-BN	-	1.5	LA471358	56	200
10G-32-0070-BN	16G-31-0070-BN	2			
10G-32-0100-BN	16G-31-0100-BN	3			
10G-33-0170-BN	-	5	LA471406	30	368
10G-34-0210-BN	-	7.5			
10G-35-0300-BN	-	10	LA471364	18	1123
10G-35-0400-BN	-	15			
10G-36-0500-BN	-	20			

AC10 (IP20) Part Number	AC10 (IP66) Part Number	HP Rating	DB Kit Part Number	Resistance [Ohms]	Power [W]
10G-41-0006-BN	-	0.25	LA471353	500	60
10G-41-0010-BN	-	0.5			
10G-41-0015-BN	-	0.75			
10G-42-0020-BN	16G-41-0020-BN	1	LA471355	200	100
10G-42-0030-BN	-	1.5			
10G-42-0040-BN	16G-41-0040-BN	2			
10G-42-0065-BN	16G-41-0065-BN	3			
10G-43-0090-BN	16G-41-0090-BN	5.0	LA471357	100	200
10G-43-0120-BN	16G-42-0120-BN	7.5			
10G-44-0170-BN	16G-42-0170-BN	10			
10G-44-0230-BN	16G-43-0230-BN	15	LA471359	56	500
10G-45-0320-BN	16G-43-0320-BN	20			
10G-45-0380-BN	16G-44-0380-BN	25	LA471361	30	750
10G-45-0440-BN	16G-44-0440-BN	30			
10G-46-0600-BN	16G-44-0600-BN	40	LA471362	25	756
10G-47-0750-BN	16G-45-0750-BN	50			
10G-47-0900-BN	16G-45-0900-BN	60	LA471365	15	1135
10G-48-1100-BN	16G-45-1100-BN	75			
10G-48-1500-BN	16G-46-1500-BN	100			
10G-49-1800-BN	16G-46-1800-BN	125	LA471367	8	1502
10G-49-2200-BN	-	150			
10G-410-2650-BN	-	200	LA471369	6	2258
10G-411-3200-BN	-	225			
10G-411-3600-BN	-	250			



Order Code

AC10

	1	2		3	4		5		6	7
Order example	10	G	-	1	1	-	0015	-	B	N

1	Product Family	
10	AC10 VFD - IP20	
2	Industry	
G	General Purpose	
3	Voltage	
1	230V Single Phase	
3	230V Three Phase	
4	480V Three Phase	
4, 5	Frame Size, Rated Current	
230V Supply		
1-0015	0.25 HP/0.2 kW	
1-0025	0.5 HP/0.4 kW	
1-0035	0.75 HP/0.55 kW	
1-0045	1 HP/0.75 kW	
2-0050	1.5 HP/1.1 kW	
2-0070	2 HP/1.5 kW	
2-0100	3 HP/2.2 kW	
3-0170 *	5 HP/3.7 kW	
4-0210 *	7.5 HP/5.5 kW	
5-0300 *	10 HP/7.5 kW	
5-0400 *	15 HP/11 kW	
6-0500 *	20 HP/15 kW	
480V Supply		
1-0006	0.25 HP/0.2 kW	
1-0010	0.5 HP/0.4 kW	
1-0015	0.75 HP/0.55 kW	
2-0020	1 HP/0.75 kW	
2-0030	1.5 HP/1.1 kW	
2-0040	2 HP/1.5 kW	
2-0065	3 HP/2.2 kW	
3-0090	5 HP/4.0 kW	
3-0120	7.5 HP/5.5 kW	
4-0170	10 HP/7.5 kW	
4-0230	15 HP/11 kW	
5-0320	20 HP/15 kW	
5-0380	25 HP/18.5 kW	
5-0440	30 HP/22 kW	
6-0600	40 HP/30 kW	
7-0750	50 HP/37 kW	
7-0900	60 HP/45 kW	
8-1100	75 HP/55 kW	
8-1500	100 HP/75 kW	
9-1800	125 HP/90 kW	
9-2200	150 HP/110 kW	
10-2650	200 HP/132 kW	
11-3200	225 HP/160 kW	
11-3600	250 HP/180 kW	
6	Braking Module	
B	Braking Module Installed	
7	EMC Filter	
N	No Filter Installed	
F	C3 EMC Filter Installed	

1	Product Family	
16	AC10 VFD - IP66	
2	Industry	
G	General Purpose	
3	Voltage	
1	230V Single Phase	
3	230V Three Phase	
4	480V Three Phase	
4, 5	Frame Size, Rated Current	
230V Supply		
1-0025	0.5 HP/0.4 kW	
1-0045	1 HP/0.75 kW	
1-0070	2 HP/1.5 kW	
1-0100	3 HP/2.2 kW	
480V Supply		
1-0020	1 HP/0.75 kW	
1-0040	2 HP/1.5 kW	
1-0065	3 HP/2.2 kW	
1-0090	5 HP/4.0 kW	
2-0120	7.5 HP/5.5 kW	
2-0170	10 HP/7.5 kW	
3-0230	15 HP/11 kW	
3-0320	20 HP/15 kW	
4-0380 **	25 HP/18.5 kW	
4-0440 **	30 HP/22 kW	
4-0600 **	40 HP/30 kW	
5-0750 **	50 HP/37 kW	
5-0900 **	60 HP/45 kW	
5-1100 **	75 HP/55 kW	
6-1500 **	100 HP/75 kW	
6-1800 **	125 HP/90 kW	
6	Braking Module	
B	Braking Module Installed	
7	EMC Filter	
N	No Filter Installed	
F	C3 EMC Filter Installed	

* Rating available with three phase input only

** Rating not UL listed

Parker Worldwide

AE – UAE, Dubai

Tel: +971 4 8127100
parker.me@parker.com

AR – Argentina, Buenos Aires

Tel: +54 3327 44 4129

AT – Austria, Wiener Neustadt

Tel: +43 (0)2622 23501-0
parker.austria@parker.com

AT – Eastern Europe, Wiener Neustadt

Tel: +43 (0)2622 23501 900
parker.easteurope@parker.com

AU – Australia, Castle Hill

Tel: +61 (0)2-9634 7777

AZ – Azerbaijan, Baku

Tel: +994 50 2233 458
parker.azerbaijan@parker.com

BE/LU – Belgium, Nivelles

Tel: +32 (0)67 280 900
parker.belgium@parker.com

BR – Brazil, Cachoeirinha RS

Tel: +55 51 3470 9144

BY – Belarus, Minsk

Tel: +375 17 209 9399
parker.belarus@parker.com

CA – Canada, Milton, Ontario

Tel: +1 905 693 3000

CH – Switzerland, Etoy

Tel: +41 (0)21 821 87 00
parker.switzerland@parker.com

CL – Chile, Santiago

Tel: +56 2 623 1216

CN – China, Shanghai

Tel: +86 21 2899 5000

CZ – Czech Republic, Klecany

Tel: +420 284 083 111
parker.czechrepublic@parker.com

DE – Germany, Kaarst

Tel: +49 (0)2131 4016 0
parker.germany@parker.com

DK – Denmark, Ballerup

Tel: +45 43 56 04 00
parker.denmark@parker.com

ES – Spain, Madrid

Tel: +34 902 330 001
parker.spain@parker.com

FI – Finland, Vantaa

Tel: +358 (0)20 753 2500
parker.finland@parker.com

FR – France, Contamine s/Arve

Tel: +33 (0)4 50 25 80 25
parker.france@parker.com

GR – Greece, Athens

Tel: +30 210 933 6450
parker.greece@parker.com

HK – Hong Kong

Tel: +852 2428 8008

HU – Hungary, Budapest

Tel: +36 1 220 4155
parker.hungary@parker.com

IE – Ireland, Dublin

Tel: +353 (0)1 466 6370
parker.ireland@parker.com

IN – India, Mumbai

Tel: +91 22 6513 7081-85

IT – Italy, Corsico (MI)

Tel: +39 02 45 19 21
parker.italy@parker.com

JP – Japan, Tokyo

Tel: +81 (0)3 6408 3901

KR – South Korea, Seoul

Tel: +82 2 559 0400

KZ – Kazakhstan, Almaty

Tel: +7 7272 505 800
parker.easteurope@parker.com

LV – Latvia, Riga

Tel: +371 6 745 2601
parker.latvia@parker.com

MX – Mexico, Apodaca

Tel: +52 81 8156 6000

MY – Malaysia, Shah Alam

Tel: +60 3 7849 0800

NL – The Netherlands, Oldenzaal

Tel: +31 (0)541 585 000
parker.nl@parker.com

NO – Norway, Ski

Tel: +47 64 91 10 00
parker.norway@parker.com

NZ – New Zealand, Mt Wellington

Tel: +64 9 574 1744

PL – Poland, Warsaw

Tel: +48 (0)22 573 24 00
parker.poland@parker.com

PT – Portugal, Leca da Palmeira

Tel: +351 22 999 7360
parker.portugal@parker.com

RO – Romania, Bucharest

Tel: +40 21 252 1382
parker.romania@parker.com

RU – Russia, Moscow

Tel: +7 495 645-2156
parker.russia@parker.com

SE – Sweden, Spånga

Tel: +46 (0)8 59 79 50 00
parker.sweden@parker.com

SG – Singapore

Tel: +65 6887 6300

SK – Slovakia, Banská Bystrica

Tel: +421 484 162 252
parker.slovakia@parker.com

SL – Slovenia, Novo Mesto

Tel: +386 7 337 6650
parker.slovenia@parker.com

TH – Thailand, Bangkok

Tel: +662 717 8140

TR – Turkey, Istanbul

Tel: +90 216 4997081
parker.turkey@parker.com

TW – Taiwan, Taipei

Tel: +886 2 2298 8987

UA – Ukraine, Kiev

Tel: +380 44 494 2731
parker.ukraine@parker.com

UK – United Kingdom, Warwick

Tel: +44 (0)1926 317 878
parker.uk@parker.com

US – USA, Cleveland

Tel: +1 216 896 3000

VE – Venezuela, Caracas

Tel: +58 212 238 5422

ZA – South Africa, Kempton Park

Tel: +27 (0)11 961 0700
parker.southafrica@parker.com

