

# In-Position Technologies

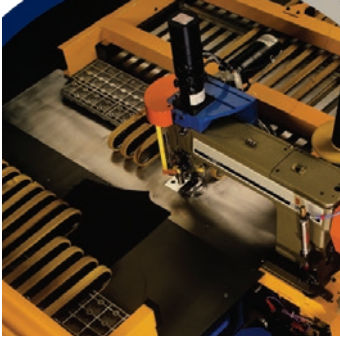

## AC30 Variable Speed Drive

For Open and Closed-Loop Applications  
0.75 - 450 kW Standard Drive



ENGINEERING YOUR SUCCESS.



**WARNING – USER RESPONSIBILITY**

**FAILURE OR IMPROPER SELECTION OR IMPROPER USE OF THE PRODUCTS DESCRIBED HEREIN OR RELATED ITEMS CAN CAUSE DEATH, PERSONAL INJURY AND PROPERTY DAMAGE.**

- This document and other information from Parker-Hannifin Corporation, its subsidiaries and authorized distributors provide product or system options for further investigation by users having technical expertise.
- The user, through its own analysis and testing, is solely responsible for making the final selection of the system and components and assuring that all performance, endurance, maintenance, safety and warning requirements of the application are met. The user must analyze all aspects of the application, follow applicable industry standards, and follow the information concerning the product in the current product catalog and in any other materials provided from Parker or its subsidiaries or authorized distributors.
- To the extent that Parker or its subsidiaries or authorized distributors provide component or system options based upon data or specifications provided by the user, the user is responsible for determining that such data and specifications are suitable and sufficient for all applications and reasonably foreseeable uses of the components or systems.

### Product Overview

Feature Overview .....	6
Modular System Overview .....	8
Control Module Options .....	9
System Design - Power.....	10
System Connectivity.....	12
Applications.....	14
Total Life-Cycle Support .....	15
Energy Savings.....	16
Industry 4.0 .....	17
Single-Axis Applications .....	18
Multi-Axis Applications.....	19
Parker Drive Quicktool (PDQ) Software.....	20
Parker Drive Developer (PDD) Software.....	21

### Technical Characteristics..... 22

Electrical Characteristics .....	23
Environmental Characteristics .....	23
Standards and Conformance .....	23
Dimensions .....	24
Connections .....	25

### Accessories and Options ..... 28

Drive Line Regen Unit .....	28
Operator Keypad .....	29
Data Storage and Cables .....	29
Standard Through-Panel Mounting Kits.....	29
IP55 Through-Panel Mounting Kits .....	29
Cablescreening Kits .....	29
Input and Output Cards.....	30
Communication Interfaces .....	32
Ancillary Parts .....	34

### Product Configuration..... 36

Control Modules and Options .....	36
Power Stack .....	37
AC30V Complete Drives .....	38
DC Supply Unit .....	39

# Parker Hannifin

## The global leader in motion and control technologies

### A world class player on a local stage

#### Global Product Design

Parker Hannifin has more than 40 years experience in the design and manufacturing of drives, controls, motors and mechanical products. With dedicated global product development teams, Parker draws on industry-leading technological leadership and experience from engineering teams in Europe, North America and Asia.

#### Local Application Expertise

Parker has local engineering resources committed to adapting and applying our current products and technologies to best fit our customers' needs.

#### Manufacturing to Meet Our Customers' Needs

Parker is committed to meeting the increasing service demands that our customers require to succeed in the global industrial market. Parker's manufacturing teams seek continuous improvement through the implementation of lean manufacturing methods throughout the process. We measure ourselves on meeting our customers' expectations of quality and delivery, not just our own. In order to meet these expectations, Parker operates and continues to invest in our manufacturing facilities in Europe, North America and Asia.

#### Electromechanical Worldwide Manufacturing Locations

##### Europe

Littlehampton, United Kingdom  
Dijon, France  
Offenburg, Germany  
Filderstadt, Germany  
Milan, Italy

##### Asia

Wuxi, China  
Chennai, India

##### North America

Rohnert Park, California  
Irwin, Pennsylvania  
Charlotte, North Carolina  
New Ulm, Minnesota



Offenburg, Germany

#### Local Manufacturing and Support in Europe

Parker provides sales assistance and local technical support through a network of dedicated sales teams and authorized technical distributors throughout Europe.

For contact information, please refer to the Sales Offices on the back cover of this document or visit [www.parker.com](http://www.parker.com)



Milan, Italy



Littlehampton, UK

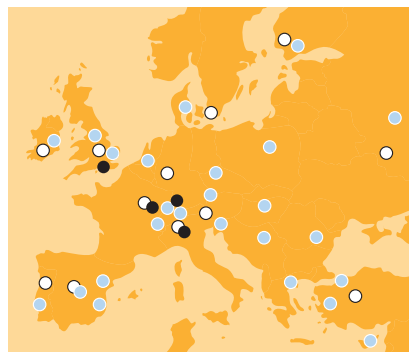

- Electromechanical Manufacturing
- Parker Sales Offices
- Distributors



Dijon, France

# Variable Speed Drive - AC30 Series

## Overview

### Description

The AC30 variable speed drive has been designed to provide users with exceptional levels of motor control, from simple open-loop pumps and fans through to closed-loop process line applications.

The AC30 combines advanced performance with exceptional ease of use, making even the most complex applications simple to achieve.

Working with the five principles of Flexibility, Simplicity, Reliability, Connectivity and Capability our engineers have created a product focussed on making the benefits of quality motor control available to every business.

Parker provides easy to use software tools for all levels of experience; enabling users to address any application. Simple applications can be setup in seconds and more complex applications can be configured in the simplest and most logical way. Programming can be via the keypad, Parker Drive QuickTool software or the Codysys based Parker Drive Developer with full IEC 61131 PLC Functionality.

The AC30 provides users with access to a large library of application macros and worked examples. While users are free to develop their own applications, they can also save time and development cost by accessing and customising examples of completed solutions.

To enable connectivity into a wide range of automation systems the AC30 features Profinet and Ethernet IP through dual Ethernet ports, as well as Modbus TCP IP with client and server functionality. That makes the AC30 series compatible with more than 80 percent of automation architecture; there is no need for expensive add-ons or upgrade modules.

The Ethernet protocols also provide potential for intelligent data analytics and connection to external servers – opening up links to the cloud or big data functionality.

So whether for standalone use or for integration into a complex automation system, the AC30 offers an easy to use solution for both simple and advanced motor control applications.



### Technical Characteristics - Overview

Ratings								
380-480 (±10 %) VAC Supplies Three Phase								
Normal Duty				Heavy Duty				Frame
kW	hp	Output Current [A <sub>rms</sub> ]		kW	hp	Output Current [A <sub>rms</sub> ]		
		400 V	460 V			400 V	460 V	
1.1	1.5	3.5	3.0	0.75	1	2.5	2.1	D
2.2	3	5.5	4.8	1.5	2	4.5	3.4	D
4	5	10	7.6	3	4	7.5	5.8	D
5.5	7.5	12	11	4	5	10	7.6	D
7.5	10	16	14	5.5	7.5	12	11	E
11	15	23	21	7.5	10	16	14	E
15	20	32	27	11	15	23	21	F
18.5	25	38	36	15	20	32	27	F
22	30	45	40	18.5	25	38	36	G
30	40	60	52	22	30	45	40	G
37	50	73	65	30	40	60	52	G
45	60	87	77	37	50	73	65	H
55	75	105	96	45	60	87	77	H
75	100	145	124	55	75	105	96	H
90	125	180	156	75	100	145	124	J
110	150	205	180	90	125	180	156	J
132	200	260	240	110	150	205	180	J
160	250	315	302	132	200	260	240	K
200	300	380	361	160	250	315	302	K
250	350	440	414	200	300	380	361	K
280	450	530	520	250	400	480	480	L
315	500	590	590	280	450	530	520	L
355	550	650	650	315	500	590	590	M
400	600	700	680	355	550	650	640	M
450	650	790	770	400	600	700	700	N

# Designed with you in mind

## Flexibility

A fully featured list of standard functionality along with the use of common control and option modules allows users to put the drive to work in many different open- or closed-loop applications.

## Simplicity

From the clear and concise backlit LCD display to the easy to use programming software, AC30 has been engineered to make the process of commissioning, operating and maintaining the drive as easy as possible.

## Reliability

Parker engineers have taken every possible step to reduce the likelihood of problems occurring, including a number of features in the AC30 that will ensure any loss of productivity is minimised and production restarted as safely and as soon as possible.

## Connectivity

Its flexible and highly modular construction enables a wide range of communications and I/O modules to be easily added as required. This enables AC30 to be used in advanced applications including multiple drive configurations.

## Capability

Integrated macros for a range of applications and PLC functionality enable more capable users to create sophisticated control that would previously have required a separate PLC. The AC30 can be integrated into even the most complex systems.



## Engineered cooling improves reliability

- Intelligent design minimises force ventilation requirements
- Removable fan improves maintainability
- Isolated power stack cooling path reduces contamination of control electronics



## Unobstructed access to power and dynamic brake terminals

- Terminal covers removable with drive in-situ
- Dynamic brake switch fitted as standard
- Easy access to DC Bus connections



## Suitable for harsh environments

- AC30 is conformally coated as standard and meets the requirements of environment classes 3C1, 3C2 (all defined substances) plus 3C3 and 3C4 for Hydrogen Sulphide (H<sub>2</sub>S)
- DNV marine / offshore approval



## Suited to all environments

- Internal EMC filter options up to C2 1<sup>st</sup> environment for use in commercial buildings
- CE marked to EN61800-5-1 and NRTL listed to UL508C and C22.2#14
- DC link chokes above 2.2 kW reduce harmonics to below IEC/EN61000-3-12 limits



## Compact footprint, chassis or through-panel mounting

- Multi-position feet with keyhole slots for ease of mounting
- Reduced heat radiation allows side-by-side mounting

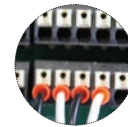
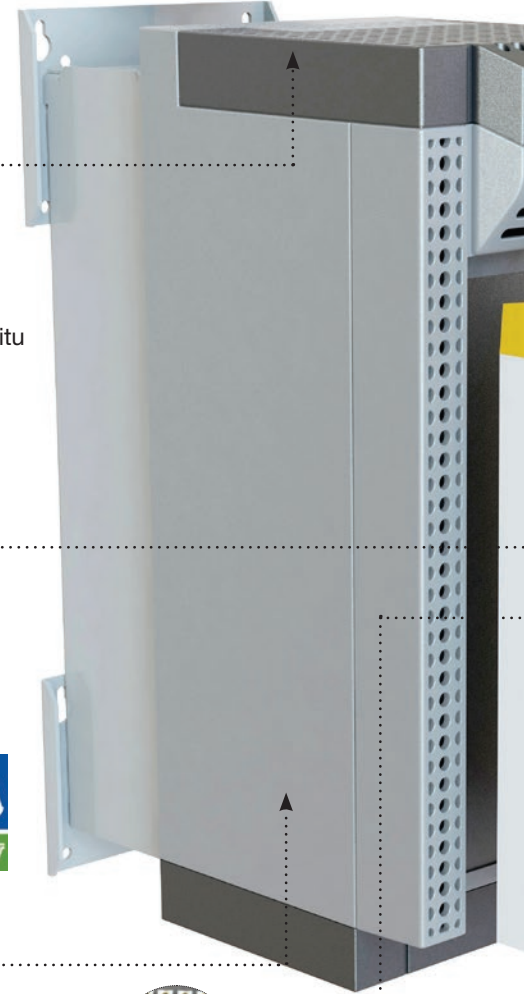

## Expandable I/O capabilities

- A range of option modules expand AC30 to accommodate application specific I/O
- High-performance, closed-loop control with pulse encoder or resolver feedback module
- Spring clamp terminals reduce installation time and risk of loose connections

## Easy to setup and use

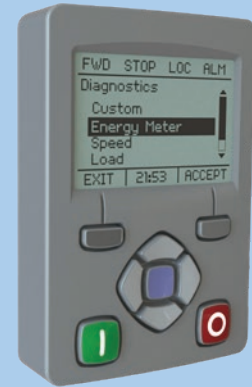

### Graphical keypad

The tactile IP55 keypad can be mounted either on the drive itself or remotely and provides access to all drive functions.

The backlit LCD display can be configured to present information in any one of a number of different languages, or even in your own custom language with your own user-defined units.

### PDQ

PDQ is a simple software tool for installing, programming and monitoring applications on the AC30 series variable speed drive. A simple wizard makes commissioning and maintain the drive application simple and easy for even the inexperienced operator.

### PDD

PDD is a fully featured PLC programming tool for the AC30 series variable speed drive, supporting all IEC-61131 languages including ladder logic, structured text and function block diagrams. It provides access to all drive parameters and enables the user to create powerful AC30 drive solutions.

### IEC 61131 PLC functionality included

- Parker Drive Developer (PDD) software lets the AC30 take greater control of its surroundings and in some cases remove the need for a PLC altogether

### Ethernet connectivity and in-built diagnostic web pages

- In-built web pages allow AC30 to be interrogated over the on-board Ethernet and Modbus TCP/IP connection

### Simplified configuration and data storage with SD cards

- SD card simplifies firmware updates and allows drive configuration and data to be stored

### Intuitive and easy to use, multi-function graphical keypad

- Remote mountable and easy to use tactile keypad makes drive setup and operation simple

### Safe-Torque-Off (STO) for safety critical applications

- Protecting users and machinery against unexpected motor start-up in accordance with EN13849-1 at PLe Cat3 or SIL 3 to EN61800-5-2

### Field-fittable communications

- Seamless integration into automation systems



# AC30 Series Variable Speed Drive Overview

The AC30 is a modular product allowing users to select power stack, control module, IO and communications modules and accessories to perfectly match the requirements of the application, making it a highly customisable yet cost effective solution. The three interchangeable control modules provide the basis for the series: the standard AC30V control module, the AC30P module with a host of advanced connectivity options and the AC30D module which adds dual encoder system capability.

## 1) Select Power Stack



Power stacks range from 0.75 to 450 kW, available in AC or DC input variants.

## 2) Select Control Module



A range of controls modules offer varying levels of intelligent automation control.

## 3) Select Comms & IO Options



A wide range of communications, fieldbus, IO and feedback options are available.

## 4) Choose accessories



Additional product accessories can be ordered to suit application and installation requirements.



## AC30 Series Capability & Connectivity



### AC30V

The AC30V is the base drive for standalone applications. Much more than a basic pump and fan drive its program can be modified with our easy to use “Parker Drive Quicktool” (PDQ) to match your exact requirements. The completed application program can then be downloaded multiple times using a simple SD card. With full access from any network via its own IP address the drive can be fully integrated into any automation system via the single, top-mounted ethernet port.

### AC30P

Supporting latest developments in the “Internet of things” and employing principles discussed in Industry 4.0 the AC30P is fully equipped with Profinet, Ethernet IP and Modbus TCP/IP via dual Ethernet ports. Using the full range of our software tools this allows more advanced applications including multiple drive configurations. Plug in via one port and access multiple drives supported by 1588 time synchronised peer to peer communication.

### AC30D

The AC30D module gives you the great features of the AC30P as well as additional built in terminals to allow dual encoder inputs and an encoder output. This gives “system Board” functionality to the AC30 allowing “electronic line shaft” capability so with this control module we can offer phase locking between drives and register control. This also frees up the I/O plug in slot to allow for even more I/O to be added if needed.

Feature	AC30V	AC30P	AC30D
Application Macros	Basic	System	System
Safety Torque Off (STO)	✓	✓	✓
Modbus Server	✓	✓	✓
Basic web server	✓	✓	✓
Parker Drive Quick (PDQ) tool programming	✓	✓	✓
DSE Developer software for legacy drive replacements	✓	✓	✓
Ethernet IP	Option	✓	✓
Profinet	Option	✓	✓
Modbus client		✓	✓
System applications libraries		✓	✓
1588 time synchronised peer to peer comms		✓	✓
SMART diagnostics		✓	✓
User customisable web server		✓	✓
Parker Drive Developer (PDD) software (Codesys IEC61131)		✓	✓
Virtual master synchronisation (same as AC890)		✓	✓
Multi-axis phase locking (same as AC690/890)		✓	✓
Resolver feedback		Option	Option
Dual encoder inputs			✓
Programmable encoder output			✓

# System Design - Power

## Versatile Power Configurations

The AC30 Series can be configured to operate in a number of different power configuration modes to suit the exact requirements of your application. The modularity of the AC30 Series enables different combinations of system components to be easily selected and installed to achieve the desired design, eliminating significant amounts of pre-engineering work.

### Building Blocks

AC30 Series is based on a variety of basic system power components which can be combined to create a number of different input power configurations. All variants are available in power ratings of 0.75 kW...450 kW.

**Standard AC Inverter (710)**  
AC fed inverter suitable for use with a 380...480 VAC input. This can be used either as a standalone drive or as the AC input drive in a multi-drive application.



**DC Fed Inverter (740)**  
DC fed inverter for use with a 500...700 VDC input. It can be used as a standalone drive where a suitable DC supply is available, or more usually as part of a multi-drive system.



**Active Front End (AFE)**  
Both the 710 and 740 power stacks can operate in AFE control mode when used with the correct control module to provide a unity power factor, four-quadrant regenerative supply.



**Line Regenerative Supply (380)**  
The Parker four-quadrant regenerative DC supply unit provides a low cost system power solution.



### Common DC Bus System (supply from a single drive)

Common DC bus system using a standard (710) inverter to supply the DC link. This design allows power sharing between drives, limiting the need for braking resistors. The power of the drives on the DC bus must not exceed double the power of the supply drive.

In all common DC systems the braking between drives is synchronised allowing brake resistors to be added to one or more drives to best fit the requirements of the application.

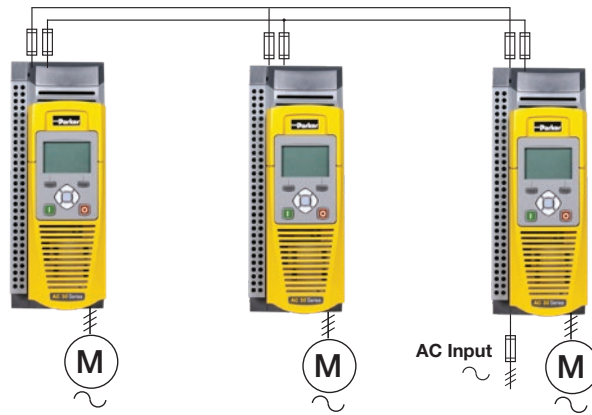

### Common DC Bus System (supply to all drives)

Common DC bus system using a standard (710) inverter with DC bus connection to all drives. This design allows power sharing between drives, limiting the need for braking resistors. Consideration is needed to include input chokes which can be required on each drive to balance the input currents between drives.

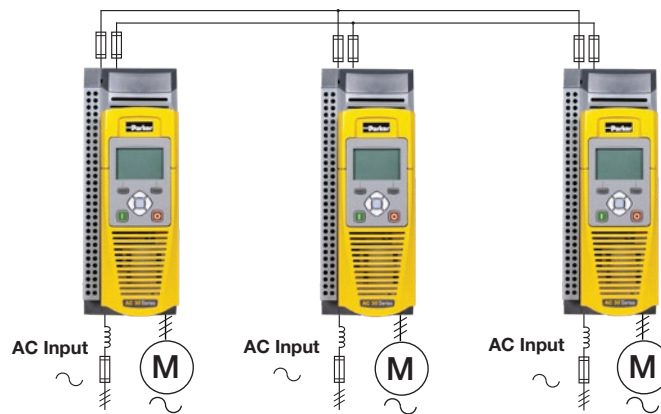

### Common DC Bus System (Active Front End - AFE)

Common DC bus system using a 710 or 740 power stack and AC30P / D control modules to act as the AFE supply unit. The AFE must have the correct LCL filter to provide a pulse width modulated (PWM) controlled IGBT converter solution to allow bi-directional power flow to the AC line. The AFE is designed for applications with a high level of regeneration into the mains supply as no energy is wasted into braking resistors. The AFE solution also provides low harmonics, unity power factor and can provide voltage boost.

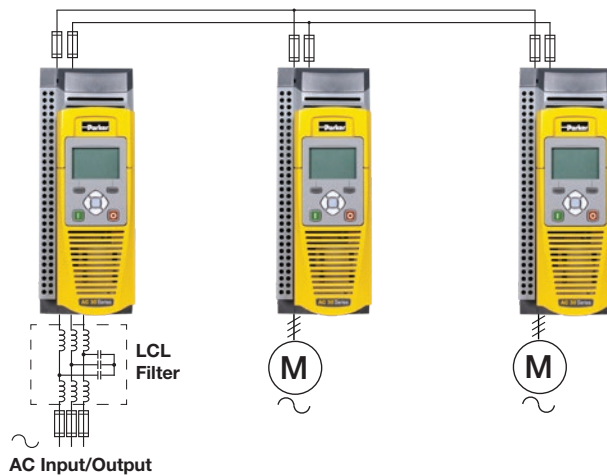

### Common DC Bus System (regenerative supply)

Common DC bus system using a 380 line regen supply unit for cost sensitive applications where low harmonic performance is not required. The line regen unit is a compact and cost effective solution for DC supply to any AC30 drive system.

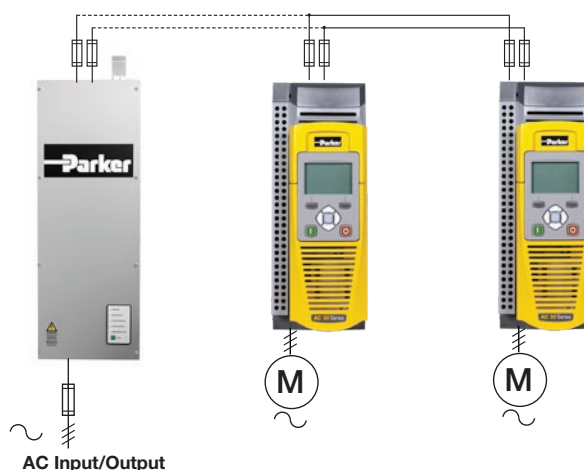

# System Connectivity

The AC30 Series can be configured to operate in a number of different power control configuration modes to suit the exact requirements of your application. The flexibility of the AC30 Series enables our range of control modules to operate standalone or as an integral part of any automation architecture.

## System Integration

The AC30 series can be easily integrated into your application supported by the wide range of connectivity options. AC30 series control modules can be programmed with our suite of software tools allowing users to configure the product to exactly match the application. Connectivity is provided via our hardware IO terminals offered on all control modules and expanded with our IO options or via standard and optional fieldbus modules.

### Hardwired IO Configuration

The AC30 series offers analogue and digital inputs and outputs to maximise application compatibility. The IO can be expanded using 7004 option modules.

Our standard application macros set each IO point to a dedicated function. For customisation the IO can be configured to match your application using PDD or PDQ.



### Fieldbus Configuration

Modbus TCP/IP is offered as standard on all AC30 control modules with profinet and ethernet IP on the AC30P and AC30D. Parker offer a wide range of communications options for easy integration into any automation network.



### Peer to Peer Configuration

The standard ethernet on the AC30P/D offers peer to peer communication between drives. This allows for seamless data transfer. The peer to peer communication is 1588 time synchronised allowing phase locking between axis.



### Parker Drive and HMI Network

The integrated PLC functionality inside the AC30 series allows applications to be programmed without a PLC. The IEC61131 flexibility and CODYSYS visualisation deliver a low cost automation solution.



### Parker Drive, PAC and HMI Network

For larger and more complex applications requiring a PLC, Parker can offer an intelligent cost-effective control solution. The AC30, PAC and PAC terminal can be programmed in a single software project.



### Parker Drive and 3rd Party Ethernet PLC Network

The AC30 can be seamlessly integrated into a control architecture via Modbus TCP/IP, Profinet and Ethernet IP without the need for any additional options. The flexibility of the AC30 software allows simple connectivity to a wide range of Ethernet master controllers.



### Parker Drive and 3rd Party PLC Network

The range of AC30 fieldbus options allow simple connectivity and integration into a wide range of control architectures.



# Applications

With 40 years experience of designing and building AC and DC drives and systems, Parker has a wealth of expertise in a host of different industries. The AC30 has been built on this experience and incorporates many flexible and innovative features, making it ideally suited for use in many industrial and commercial applications. Additional communications, expanded I/O and pulse encoder / resolver feedback option modules extend the capabilities of the AC30 still further, making it an extremely flexible and capable solution for all types of open- and closed-loop motor control requirements.

## Typical applications for AC30 include...

- Industrial Pumps
- Packaging Machines
- Textile Machine
- Machine Spindles
- Hydraulic Power Units
- Wire Drawings
- Converting Machines
- Printing Machines
- Test Stands
- Rolling Mills
- Crane Hoist Equipment
- Marine Winches
- Extruders



Industrial Pump Control



Offshore & Marine



Textile Machines

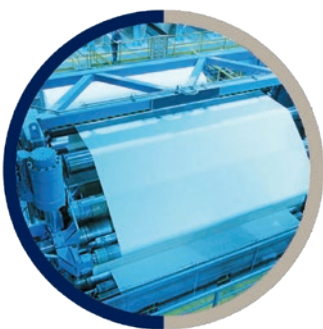

Converting



Machine Spindles



Rolling Mills

# Total Life-Cycle Support

Parker is committed to providing total life cycle support for all of its electromechanical products. Our team of application experts can support customers through every stage of product ownership.



## Pre-Sales

- Catalogues
- Brochures
- On-Line Tools
- Selection Tools



## Spares/Repairs

- Product Warranty
- Authorised Repair Centres
- Parker Repair Centre



## Training

- Customer Site Training
- Parker Site Training
- On-line training

## Application Support

- Solutions Approach
- Engineering knowledge
- Application expertise
- Product expertise



## Where to Buy

- Global availability
- Wide distribution network
- European stocking



## Installation/Commissioning

- Electrical installation
- Commissioning and start-up
- Free telephone support



**Customer**

## Simple and effective pump and fan control



### Saving energy through speed control

Pumps and fans are widely used throughout industry. Some estimates suggest that a large proportion of these can be as much as 20 % oversized for the application they are used in. When these are operated at a constant speed, a significant amount of the power consumed by the motor is wasted, costing your company considerable amounts of money and creating additional CO<sub>2</sub> emissions.

Matching the speed of pumps and fans to process demands with the AC30V ensures that the motor will always operate at the optimal speed to deliver just the right amount of air or fluid. This can result in significant energy savings. A 20 % reduction in speed will actually reduce energy consumption by almost 50 % and payback can be achieved in **less than 18 months in many cases**.

### Speed control = Savings

- Up to 50 % energy savings
- Improved power factor
- Reduced maintenance
- Quieter operation
- Increased service life
- Reduced carbon footprint

### Improved power factor and service life

Pumps and fans that continuously operate at maximum speed inevitably have shorter life spans and are subject to unnecessary wear and tear. Variable speed drives can help improve service life while also reducing energy consumption and improving the power factor of your installations.

In addition to the cut in energy costs, you'll also see significant savings with maintenance and repair bills and a noticeable reduction in noise pollution as well.

### Control by flow regulation, motor run at maximum speed

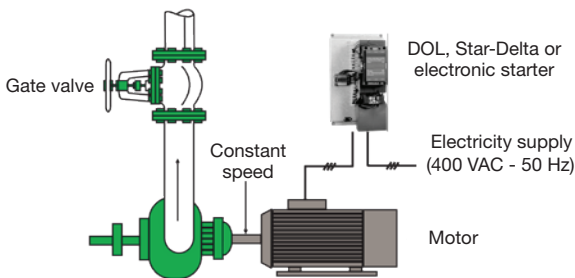

- Constant speed
- Power consumption higher than needed
- Poor power factor
- Higher energy costs
- Increased mechanical wear

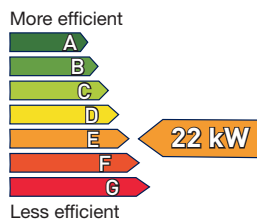

**€ 23 126/Year**  
= 22 kW x 8760 h x € 0.12/kWh

### Control by AC30 variable speed drive

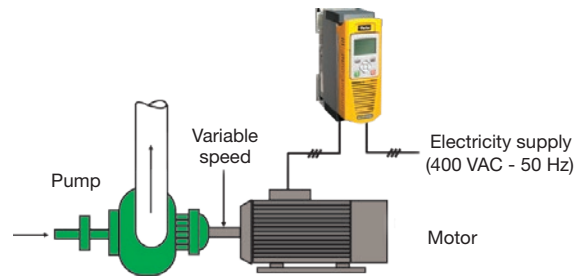

- Variable speed
- Power consumption is matched to load
- Improved power factor
- Reduced energy costs
- Reduced maintenance

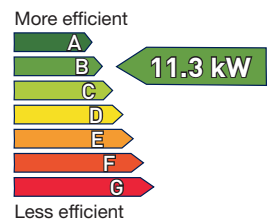

**€ 11 879/Year**  
= 11.3 kW x 8760 h x € 0.12/kWh

Assuming a 20 % reduction in speed Power  
= (.8 x .8 x 22 kW) = 11.3 kW

**Total annual energy saving = € 11 247**



## AC30 and Industry 4.0

The collective term Industry 4.0 refers to the fourth industrial revolution, typically described as the computerization of manufacturing, the merging of traditional automation with information technology. One of the underlying concepts is modular cyber-physical systems that can collaborate with the operator and communicate between themselves in real-time to make autonomous decisions, thereby adapting production processes as needed.

Connected devices in factories, offices and on the person will become smart networked nodes, interconnected via a standardised network without any hierarchy. Better process optimisation, increased productivity, safety, reliability and flexibility, will all be highly valued outcomes from successful implementations of Industry 4.0.

The AC30 has been designed to be easily integrated as part of an Industry 4.0 system, connected either directly or via a PAC controller.

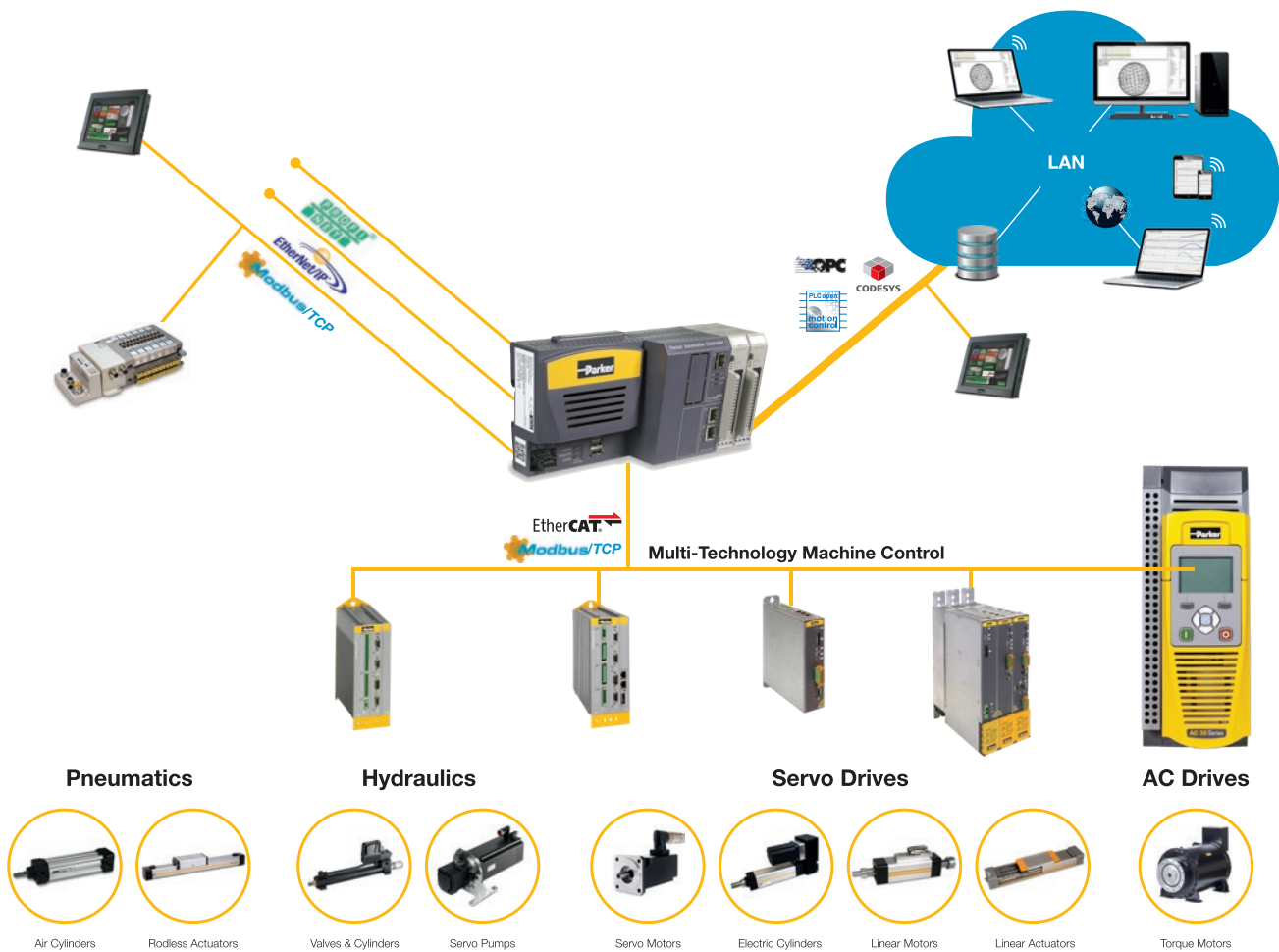

# Single Axis Applications

Making use of pre-defined control logic, application macros enables users to quickly configure the AC30 for control of one of a number of pre-defined functions. Information is presented to the user in a template format which can then be simply and easily populated with the specific details of the application. This removes the complexity of designing the application logic from scratch.

**Basic Speed Control**  
Set speed and voltage or current with start / stop direction control

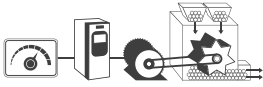

**Automatic/Manual Control**  
Set to run with local speed setting or external reference

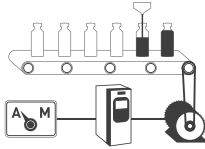

**Raise / Lower**  
Increase or reduce speed using digital inputs

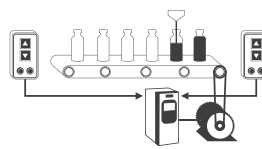

**PID Control**  
Control the pressure, flow, temperature or any process variable

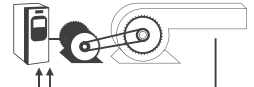

**Pump Control**  
Dedicated pump control with specific pump functionality

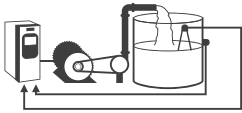

**Torque Control**  
Control the motor torque limit using an analogue input

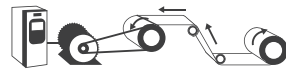

**Hydraulic Pump Applications**  
Efficient control of hydraulic pumps for accumulator charging, pressure / flow control

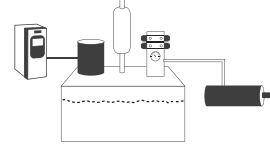

**Preset Speed Control**  
Select up to 8 pre-programmed speeds using digital inputs

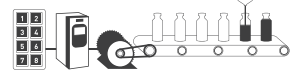

## Engineered for any motor

In addition to the energy-saving associated with VSD control of pumps and fans. Additional energy saving can be achieved by using permanent magnet (PMAC) servo motors. AC30 offers effective and affordable control of either AC induction motors or PMAC motors.

PMAC motors are up to 10% more efficient and 75% smaller than standard AC induction motors.



## Closed-loop operation

Optional pulse encoder and resolver feedback modules can be added to the AC30 for applications requiring more accurate speed or torque control of AC induction and PMAC motors.

**Automatic belt breakage detection** - Interactive monitoring of the running conditions of a fan allows AC30 to detect a breakage in the drive belt between the fan and motor, stop the motor and indicate an alarm condition.

**Catching a spinning load** - "fly-catching" - The fan control algorithms enable the AC30 to detect when a fan is free-wheeling and to regain control of it before running it at the commanded speed.

**PID Control** - Multiple PID control loops can be programmed to monitor process variables and adjust the speed of the motor accordingly to achieve the required variable setpoint.

**Intelligent pump profiles** - Our advanced intelligent pump control algorithms monitor motor loads and provides users with a number of features designed specifically for pump control applications.

**Essential services (Fire mode)** - Selected via digital input, Fire mode will cause the drive to run continuously at the maximum programmed speed ignoring all other control signals and alarm conditions.

**Energy optimisation** - Under constant speed conditions, the motor power waveforms from the drive are optimised to reduce motor energy consumption without compromising performance.

**Skip frequencies** - Up to 4 speed and frequency bands can be programmed in the AC30, to enable resonant points on the fan to be avoided, reducing vibration, wear and noise.

**Timed run function** - 10 daily start/stop events can be programmed with different running speeds across a 7 day period.

**Process Timers** - Multiple hours-run timers can be programmed to generate text alerts on the drive keypad to coincide with process maintenance intervals.

## Multi Axis Applications

The AC30 series is ideal for integration into wide range of applications. The intelligent automation features it provides allow it to be integrated into advanced systems.

**Parker Drive Developer (PDD) software** for programming of multiple axis software nodes in a single software project. The project source code can be quickly saved to an SD card or with AC30 P&D it can be stored in the internal drive memory. This allows the entire software project to be extracted from the drive on site, modified and re-saved.

**AC30P and D include dual ethernet ports** to allow for simple peer-to-peer wiring and interconnection into external automation control systems via Modbus TCP/IP, Profinet and Ethernet IP.

**AFE operating mode** on the AC30P and D for the four quadrant control of a drive system DC link. This is achieved when used in combination with a Pulse Encoder Speed Feedback Option (7004-04-00) connected to an external AFE Line Sync Module (LA471892U001), as the mains synchronisation input.

**Peer to Peer 1588 time synchronisation** between drive nodes allowing multiple axis to operate seamlessly in a line configuration. Speed following, phase locking and registration are supported with pre configured software functions. The AC30D allows for a real master to be used as a speed reference in the form of an encoder input which can be cascaded via the encoder repeated output or generated by a virtual master.

**Speed feedback auto-changeover** in case of failure is a new intelligent feature supported by the AC30P/D series. The drive can recognise a fault condition with the encoder feedback by the difference between the speed feedback signal and that of an internal speed estimator. The drive then performs an on-the-fly changeover to sensorless control and provides a warning to the user. This allows production to continue up to a planned stoppage. This feature can maximise production availability and minimise scrap and wastage in many process line applications.

**Intelligent diagnostics and data logging** allow users to monitor system performance and manage system warnings by taking corrective action before faults or trips occur. Eight user-definable trips can be configured in the application, each with an associated warning and user-definable name. Parameter data may be logged to an SD card, captured with real-time stamps when fitted with the optional RTC card. "Black Box" trip history accurately captures drive status in the lead up to a trip event. This data may be transferred to a readable .csv file on the optional SD card.

**SMART brake resistor sharing** in common-bus systems is provided so the brake switch is disabled when its IxT limit is reached, but without tripping. Braking voltage level also increases gently as the IxT is accumulated. This approach facilitates better braking energy sharing in distributed resistor systems.



### Engineered for any system

The AC30 series is designed to be integrated into any multi-axis drive system. The flexibility of power and control on this modular product allows users to design systems to perfectly match their application.



## Parker Drive Quicktool (PDQ) Software

### Description

PDQ is a simple software tool for installing, programming and monitoring applications on the AC30 series variable speed drive.

Communication between the drive and PC is via the in-built Ethernet port and the software automatically detects all AC30 drives connected to the Ethernet network.

Once the drive is selected, a simple wizard guides the user through the installation process. Starting with the required application the user is asked to choose their motor data from a motor database or enter their own specific data, to configure the I/O and communications and finally commission the drive. The drive parameters can then be monitored, charted and adjusted.

The drive also supports its own webserver providing access to all drive parameters for quick and easy changes.



Parker Drive Quicktool is shipped with every drive and can also be downloaded for free from the Parker website. [www.parker.com/ssd/pdq](http://www.parker.com/ssd/pdq)

## Parker Drive Developer (PDD) Software

### Description

PDD is a fully featured PLC programming tool for the AC30 series variable speed drive, supporting all IEC-61131 languages including ladder logic, structured text and function block diagrams.

It provides access to all drive parameters and enables the user to create powerful AC30 drive solutions. It's also possible to create custom parameters and menus so the user can describe the setup and status of the drive in the context of their own application.

To help start the development process Parker provides pre-installed libraries with the following functionality:

- Basic Speed Control
- Fan and Pump Control
- Winder Blocks
- Cascaded Pump Control

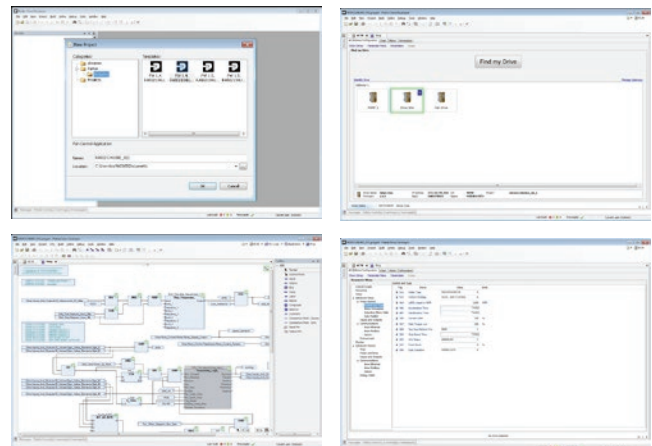

## Technical Characteristics

### AC30 Power Stack Ratings

Power Stack Order Code	Normal Duty Ratings			Heavy Duty Ratings			Frame
	kW/HP	Output Current $A_{rms}$		kW/HP	Output Current $A_{rms}$		
		400 VAC	460 VAC		400 VAC	460 VAC	
380-480 (± 10 %) VAC Supplies Three Phase							
7x0-4D0004-B...	1.1/1.5	3.5	3.0	0.75/1	2.5	2.1	D
7x0-4D0006-B...	2.2/3	5.5	4.8	1.5/2	4.5	3.4	D
7x0-4D0010-B...	4/5	10	7.6	3/4	7.5	5.8	D
7x0-4D0012-B...	5.5/7.5	12	11	4/5	10	7.6	D
7x0-4E0016-B...	7.5/10	16	14	5.5/7.5	12	11	E
7x0-4E0023-B...	11/15	23	21	7.5/10	16	14	E
7x0-4F0032-B...	15/20	32	27	11/15	23	21	F
7x0-4F0038-B...	18/25	38	36	15/20	32	27	F
7x0-4G0045-B...	22/30	45	40	18/25	38	36	G
7x0-4G0060-B...	30/40	60	52	22/30	45	40	G
7x0-4G0073-B...	37/50	73	65	30/40	60	52	G
7x0-4H0087-B...	45/60	87	77	37/50	73	65	H
7x0-4H0105-B...	55/75	105	96	45/60	87	77	H
7x0-4H0145-B...	75/100	145	124	55/75	105	96	H
7x0-4J0180-B...	90/125	180	156	75/100	145	124	J
7x0-4J0205-B...	110/150	205	180	90/125	180	156	J
7x0-4J0260-B...	132/200	260	240	110/150	205	180	J
7x0-4K0315-B...	160/250	315	302	132/200	260	240	K
7x0-4K0380-B...	200/300	380	361	160/250	315	302	K
7x0-4K0440-B...	250/350	440	414	200/300	380	361	K
7x0-4L0530-N...	280/450	530	497	250/400	480	442	L
7x0-4L0590-N...	315/500	590	550	280/450	530	497	L
7x0-4M0650-N...	355/550	650	602	315/500	590	548	M
7x0-4M0700-N...	400/600	700	657	355/550	650	603	M
7x0-4N0790-N...	450/650	790	713	400/600	700	659	N

See Ordering Information for full order codes and description.

## Electrical Characteristics

<b>Power Supply</b>	<b>400 V Nominal</b>	
<b>Rated Input Voltage</b>	3 x 380...480 VAC ±10 %	
<b>Input Frequency</b>	45...65 Hz	
<b>Maximum Switching Frequency</b>	2 kHz up to maximum of 12 kHz - de-rating may apply	
<b>Overload: Heavy Duty</b>	150 % for 60 s - 180 % for 3 s (frames D to K)	
<b>Overload: Normal Duty</b>	110 % for 60 s - 180 % of HD FLC. for 3 s (frames D to K)	
<b>Output Frequencies</b>	0...590Hz	0...500 Hz at 4 kHz switching frequency* 0...1000 Hz at 8 kHz switching frequency* 0...1500 Hz at 12 kHz switching frequency*
<b>Earth Leakage Current</b>	>10 mA (all models)	

\*Subject to export license agreement

## Environmental Characteristics

<b>Operating Temperature</b>	0...+40 °C Normal Duty, 0...+45 °C Heavy Duty. Derate up to a maximum of +50 °C
<b>Storage Temperature</b>	-25...+55 °C
<b>Shipping Temperature</b>	-25...+70 °C
<b>Product Enclosure Rating</b>  (Cubicle mounted) (Through-panel mounted)	IP20 - remainder of surfaces (Europe) UL (c-UL) Open Type (North America/Canada) IP20 UL (c-UL) Open Type (North America/Canada) IP20 UL (c-UL) Open Type (North America/Canada) (frames D to K)
<b>Altitude</b>	1000 m ASL. Derate output by 1 % per 100 m to a maximum of 2000 m
<b>Operating Humidity</b>	Maximum 85 % relative humidity at 40 °C non-condensing
<b>Atmosphere</b>	Non-flammable, non-corrosive and dust free
<b>Climatic Conditions</b>	Class 3k3, as defined by EN60721-3-3
<b>Chemically Active Substances</b>	For the standard product, compliance with EN60271-3-3 is: <ul style="list-style-type: none"> <li>• Both classes 3C3 and 3C4 for Hydrogen Sulphide gas (H<sub>2</sub>S) at a concentration of 25 ppm for 1200 hours</li> <li>• Both classes 3C1 (rural) and 3C2 (urban) for all 9 defined substances as defined in table 4</li> </ul>
<b>Operating Vibration</b>	Test Fc of EN60068-2-6 10 Hz<=f<=57 Hz sinusoidal 0.075 mm amplitude 57 Hz<=f<=150 Hz sinusoidal 1 g 10 sweep cycles per axis on each of three mutually perpendicular axis
<b>Overvoltage Category</b>	Overvoltage category III (numeral defining an impulse withstand level)
<b>Pollution Degree</b>	Pollution degree II (non-conductive pollution, except for temporary condensation) for control electronics Pollution Degree III (dirty air rating) for through-panel mounted parts

## Standards and Conformance

<b>North America/Canada</b>	Complies with the requirements of UL508C and CSA22.2 #14 as an open-type drive
<b>European LV Directive</b>	This product conforms with the Low Voltage Directive 2006/95/EC
<b>European EMC Directive</b>	CE Marked in accordance with 2004/108/EC
<b>RoHS Compliance</b>	This product complies with RoHS substance restrictions in accordance with EC Directive 2011/65/EU
<b>Reach</b>	This product complies with the REACH regulations EC1907/2006
<b>European Machinery Directive</b>	Safe-Torque-Off (STO) complies with the requirements of ISO13849-1 (Safety-related parts of control systems) at PLe Cat3 or SIL 3 to EN61800-5-2
<b>DNV Marine Certification (Det Norske Veritas)</b>	Complies with the 'Classification of Ships, High Speed & Light Craft and Det Norske Veritas Offshore Standards'. This applies to all AC30 Frequency converters with powers up to 75kW for use in marine and offshore applications

## Dimensions

### Panel Mounting

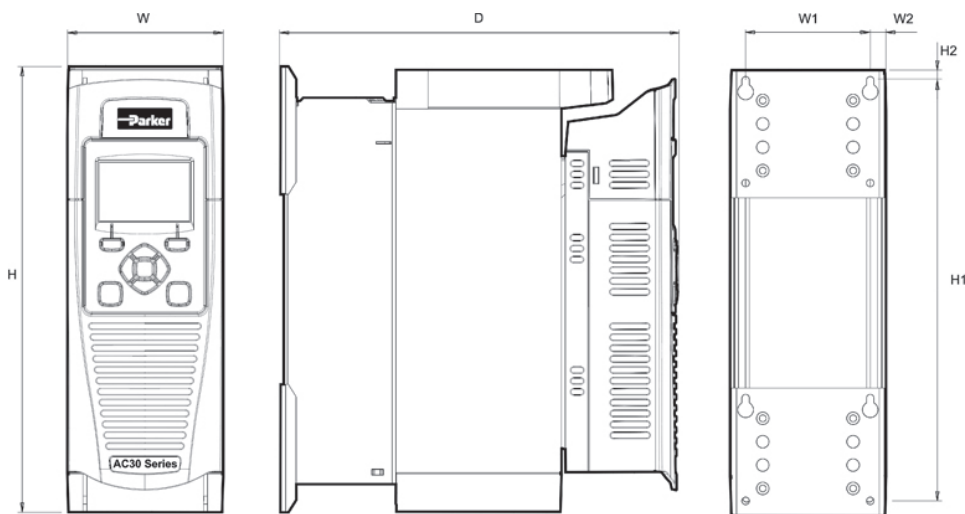

Dimensions [mm]

Model	Max. Weight [kg]	H	H1	H2	W	W1	W2	D	Fixings
Frame D	4.5	286	270	6.5	100	80	10.0	255	Slot 4.5 mm wide. Use M4 fixings
Frame E	6.8	333	320	6.5	125	100	12.5	255	
Frame F	10	383	370	6.5	150	125	12.5	255	
Frame G	22.3	480	465	7.25	220	190	15	287	Slot 5.0 mm wide. Use M5 fixings
Frame H	42.8	670	650	10	260	220	20	331	
Frame J	89	800	780	10	330	285	22.5	374	Use M8 fixings
Frame K	125	1300	1272	14	400	280	60	385	Use M10 fixings
Frame L	182	1340	1310	15	535	470	32	378	Use M10 fixings
Frame M	240	1463	1448	15	604	545	29.5	378	Use M10 fixings
Frame N	266	1593	1563	15	604	545	29.5	378	Use M10 fixings

\*The AC30D control module increases the shown depth by 18mm on all frame sizes.

### Through Panel Mounting

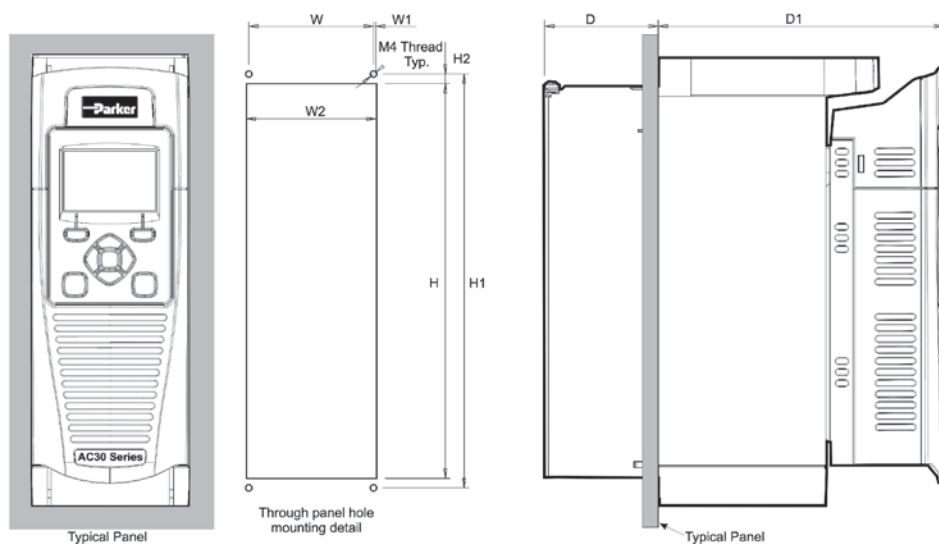

Dimensions [mm]

Model	H	H1	H2	W	W1	W2	D	D1	Fixings
Frame D	250	262	6	79	1.5	82	72	181	Use M4 fixings
Frame E	297	309	6	102	1	104	72	181	
Frame F	347	359	6	127	1	129	72	181	
Frame G	440	455.8	7.9	195	0.4	195.8	95	190	Use M5 fixings
Frame H	617	641	12	218	4.5	227	99	211	Use M6 Fixings
Frame J	745	765	10	275	12.5	300	128	242.6	Use M6 Fixings

Through panel mounting is not possible for frame K to N.



## Connections

### Power connections

Term.	Description
DB+	Dynamic Brake Resistor
DB-	Dynamic Brake Resistor
DC+	DC Link Bus +Ve
DC-	DC Link Bus -Ve
L1	L1 AC Input Supply
L2	L2 AC Input Supply
L3	L3 AC input Supply
M1	Motor Output 1/U
M2	Motor Output 2/V
M3	Motor Output 3/W

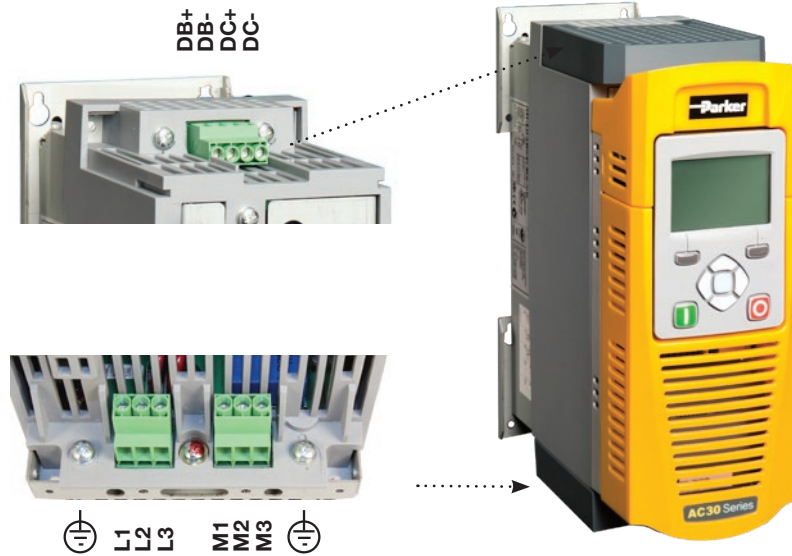

### Safe Torque Off (STO)

The AC30 series features Safe Torque Off functionality as standard, offering users protection against unexpected motor start-up in accordance with EN13849-1 at PLe Cat 3 or SIL 3 to EN61800-5-2.

The STO functionality helps protect personnel and machinery by preventing the drive from restarting automatically. It disables the drive pulses and inhibits the power supply to the motor, so that the drive cannot generate any potentially hazardous movement. The state is monitored internally within the drive.

Term.	Label	Description
X10/01	STO A Input	STO Channel A input signal
X10/02	STO Common	Return signals for STO A and STO B
X10/03	STO B Input	STO Channel B input signal
X10/04	STO Common	Return signals for STO A and STO B
X10/05	STATUS A	STO Status Indication
X10/06	STATUS B	STO Status Indication

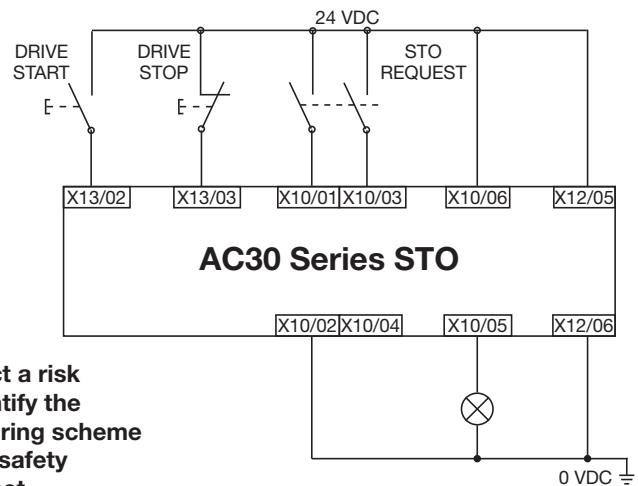

The example wiring diagram shows the minimum connections required to implement STO with the AC30 series AC drives.

**Users must conduct a risk assessment to identify the appropriate STO wiring scheme and ensure that all safety requirements are met.**



**It is the user's responsibility to ensure the safe and correct use of the STO function of the AC30 Series. User's should read and fully understand chapter 6 (Safe Torque Off) of the product user manual downloadable from [www.parker.com](http://www.parker.com).**

**Control wiring connections: AC30V and AC30P**

Term.	Label
X10/01	STO A Input
X10/02	STO Common Return
X10/03	STO B Input
X10/04	STO Common Return
X10/05	STO Status A
X10/06	STO Status B
X11/01	ANIN 01 Analogue Input ( $\pm 10$ V, 0-10 V, 0-20 mA, 4-20 mA)
X11/02	ANIN 02 Analogue Input ( $\pm 10$ V, 0-10 V)
X11/03	ANOUT 01 Analogue Output ( $\pm 10$ V, 0-10 V)
X11/04	ANOUT 02 Analogue Output (0-10 V, 0-20 mA, 4-20 mA)
X11/05	+10 V Reference
X11/06	-10 V Reference
X12/01	DIGIN04 / DIGOUT 01 Digital In/Out
X12/02	DIGIN05 / DIGOUT 02 Digital In/Out
X12/03	DIGIN06 / DIGOUT 03 Digital In/Out
X12/04	DIGIN07 / DIGOUT 04 Digital In/Out
X12/05	User +24 V Output
X12/06	0 V Common

Term.	Label
X13/01	0V Common
X13/02	DIGIN 1 Digital Input
X13/03	DIGIN 2 Digital Input
X13/04	DIGIN 3 Digital Input
X13/05	+24 V Auxiliary Input
X13/06	0 V Auxiliary Input
X14/01	Relay Output 01 (Contact A)*
X14/02	Relay Output 01 (Contact B)*
X14/03	Relay Output 02 (Contact A)*
X14/04	Relay Output 02 (Contact B)*

\*Relay outputs are not present on AC30P/D. These are replaced by dual ethernet ports.

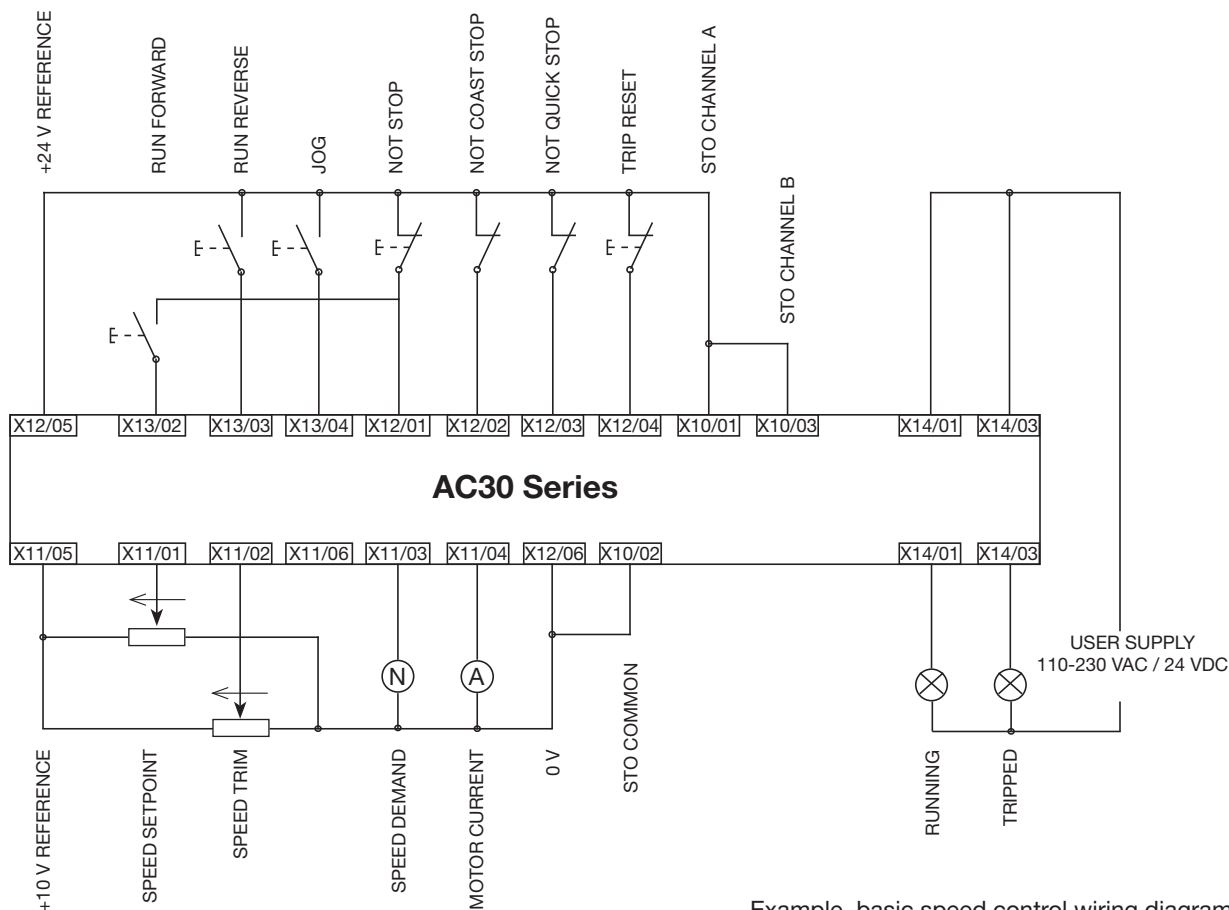
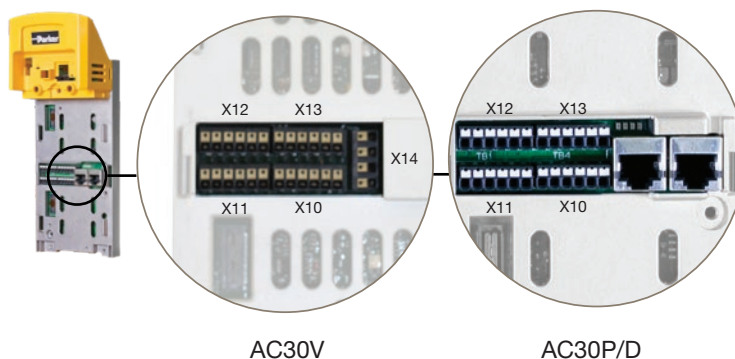

Example, basic speed control wiring diagram

### Control wiring connections: AC30D

The wiring on the AC30D is the same as AC30P with the additional systems connections shown below.

Term.	Label
X30/01	DIGIN 1
X30/02	DIGIN 2
X30/03	DIGIN 3
X30/04	DIGIN 0V
X30/05	+24V System Aux. Input
X30/06	0V System Aux. Input
X31/01	Encoder 2 - A Input
X31/02	Encoder 2 - /A Input
X31/03	Encoder 2 - B Input
X31/04	Encoder 2 - /B Input
X31/05	Encoder 2 - Z Input
X31/06	Encoder 2 - /Z Input
X31/07	Encoder PSU Output - Positive Terminal (internally connected to X32/07)
X31/08	Encoder PSU Output - 0V Terminal (internally connected to X32/08)

Term.	Label
X32/01	Encoder 1 - A Input
X32/02	Encoder 1 - /A Input
X32/03	Encoder 1 - B Input
X32/04	Encoder 1 - /B Input
X32/05	Encoder 1 - Z Input
X32/06	Encoder 1 - /Z Input
X32/07	Encoder PSU Output - Positive Terminal (internally connected to X31/07)
X32/08	Encoder PSU Output - 0V Terminal (internally connected to X31/08)
X33/01	Encoder Transmit - A Output
X33/02	Encoder Transmit - /A Output
X33/03	Encoder Transmit - B Output
X33/04	Encoder Transmit - /B Output
X33/05	Encoder Transmit - Z Output
X33/06	Encoder Transmit - /Z Output

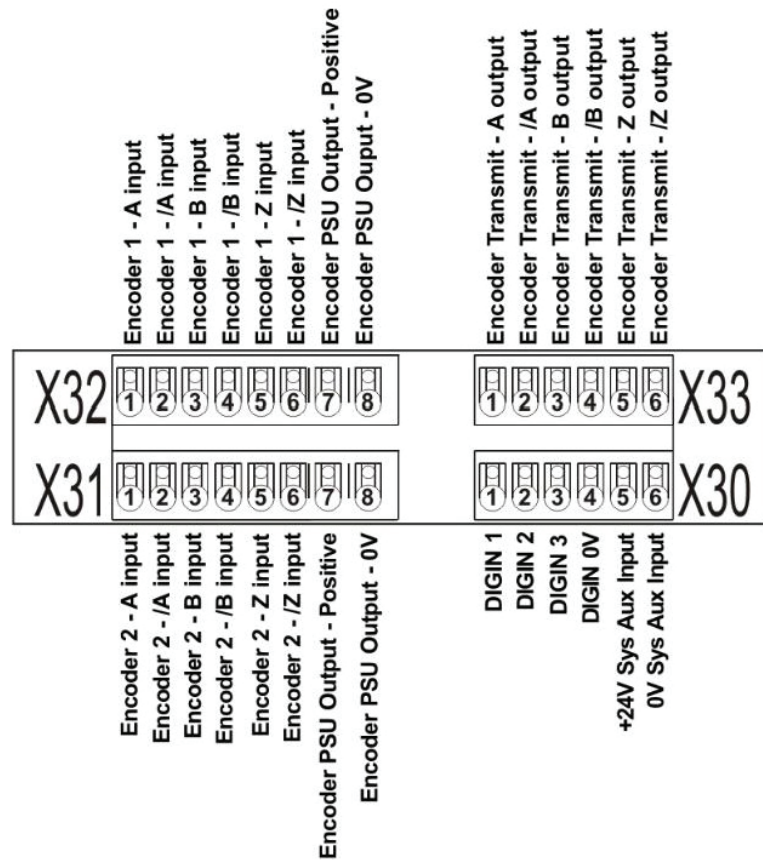
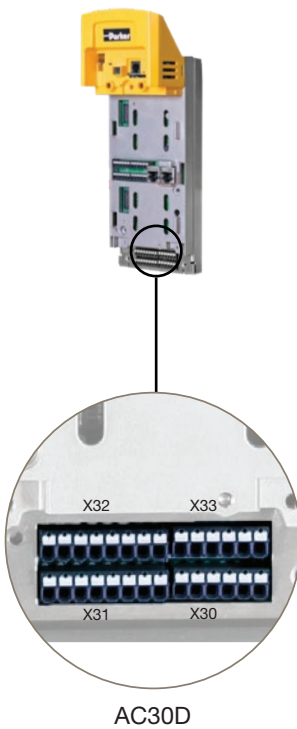

## Parker Drive Line Regen Unit

The Parker Drive Line Regen unit enables full energy flow in both directions. Line Modules centrally feed the energy into the DC link. Line Modules with regulated infeed/regenerative feedback can optionally ensure a constant DC link voltage and a high degree of compatibility with the line supply.

### Advantages

- Compact size
- Braking energy of drive systems is regenerated into the network
- No mains connection for each of the AC30 drives is required!
- Power can be perfectly adapted to the application
- Network frequency 40-60Hz
- DC intermediate circuit coupling of several drive controllers possible
- Low-loss and high-quality IGBT power unit
- Self-synchronizing
- Reliability: electronic overload protection in feedback operation
- Monitoring of mains voltage, phase rotation and temperature very high efficiency of > 99%/>98% (Drive/Regen mode) by effective real time controlling and analog operation principle
- Enables highly dynamic braking operations
- User-friendly start-up: no programming or parameter settings are required
- Significant reduction of heat loss by regenerative operation.
- Maintenance free power feedback unit due to the innovative concept
- Duty cycle=100%



### Technical Information

Order Code	Input Iac (A)		Input Idc (A)		Frame Size	Weight (Kg)	Power Loss (W)
	Driving	Regenerating	Driving	Regenerating			
380-5R0094-NE-0000	74	60	94	69	R	44	750
380-5R0157-NE-0000	124	99	157	115	R	66	1265
380-5S0251-NE-0000	198	159	251	184	S	100	1900
380-5S0394-NE-0000	310	248	394	288	S	110	2852
380-5S0536-NE-0000	422	338	536	392	S	115	3500

### Dimensions

Model	Height (mm)	Width (mm)	Depth (mm)
Frame R	754	256	320
Frame S	944	378	390

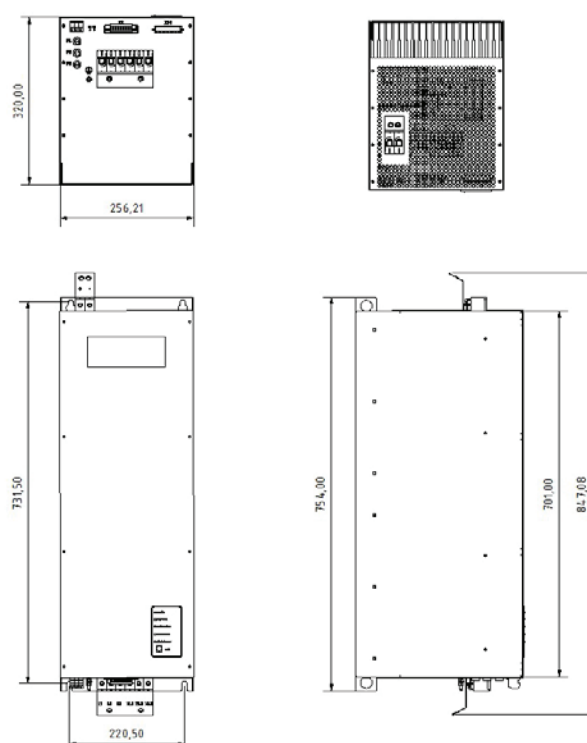

## Accessories and Options

### Operator Keypad

Order Code	Description
7001-00-00	IP54 Graphical keypad
7001-01-00	Keypad blanking cover
LA501991U300	Keypad remote mounting kit (3 m cable and screws)

#### Description:

The backlit LCD graphical keypad can be either mounted locally on the drive or remotely with the use of a remote mounting kit. The keypad has 3 pass code protected user access levels. The keypad can be used to set-up and commission the drive, change parameter settings, monitor running status or diagnose warning or alarm conditions. The display information can be shown in English, German, French, Spanish or Italian.

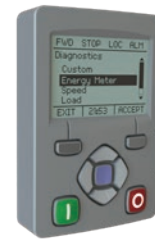

7001-00-00



7001-01-00

### Data Storage and Cables

Order Code	Description
IF502785	SD card 16GB



IF502785

### Standard Through-Panel Mounting Kits

Order Code	Description
LA502668	Frame D through panel mounting gasket kit
LA502669	Frame E through panel mounting gasket kit
LA502670	Frame F through panel mounting gasket kit
LA502471	Frame G through panel mounting gasket kit
LA502472	Frame H through panel mounting gasket kit
LA502793	Frame J through panel mounting gasket kit

### IP55 Through-Panel Mounting Kits

Order Code	Description
LA503104U001	Frame D through panel mounting gasket & fan kit
LA503104U002	Frame E through panel mounting gasket & fan kit
LA503104U003	Frame F through panel mounting gasket & fan kit
LA503104U004	Frame G (60A-73A) through panel mounting gasket & fan kit
LA503104U005	Frame H (105A-145A) through panel mounting gasket & fan kit
LA503104U006	Frame J through panel mounting gasket & fan kit
LA503104U014	Frame G (45A) through panel mounting gasket & fan kit
LA503104U015	Frame H (87A) through panel mounting gasket & fan kit

### Cablescreening Kits

Order Code	Description
LA501935U001	Frame D C2 environment filter kit
LA501935U002	Frame E C2 environment filter kit
LA501935U003	Frame F C2 environment filter kit
LA501935U004	Frame G cable screening kit
LA501935U005	Frame H cable screening kit
LA501935U006	Frame J cable screening kit
LA501935U007	30P system board screening kit

The environment filter kit consists of a motor cable ferrite core and screening brackets and is required to comply with the requirements of the EMC directive for a C2 environment with frames D, E and F. For frame G and H the drive has a different EMC internal filter which is required in addition to the screen kit. For frames J to N an external EMC filter is required.



LA501935U001

## Input and Output Cards

### 7004-01-00 - General Purpose I/O Module

Digital Inputs & Outputs	4x Digital inputs or outputs
Analogue Inputs/Outputs	2x Analogue inputs ( $\pm 10$ V)
Relay Outputs	2x Volt-free relay outputs (230 VAC, 30 VDC)
Motor Thermistor Inputs	1x Motor thermistor input
Time Format*	Seconds
Accuracy (drive powered)*	$\pm 1$ minute / month (RTC trim=0)
Accuracy (drive unpowered)*	$\pm 5$ minutes / month (RTC trim=0)
Battery Backup Duration*	6 Months



Terminal	Label
X20/01	DIN11/DOU11
X20/02	DIN12/DOU12
X20/03	DIN13/DOU13
X20/04	DIN14/DOU14
X20/05	+24 VDC
X20/06	0 VDC COMMON
X21/01	REFERENCE
X21/02	ANIN11
X21/03	REFERENCE
X21/04	ANIN12
X22/01	MOTOR THERMISTOR
X22/02	MOTOR THERMISTOR
X23/01	RLY11
X23/02	RLY11
X23/04	RLY12
X23/04	RLY12

#### Description:

The general purpose I/O (GPIO) option module can be fitted to all AC30 series drives in the upper I/O option module slot. The modules are field-fittable and offer users the opportunity to expand the drives standard I/O capability, allowing more complex motor control solutions to be implemented.

The 7004-01-00 with real-time clock (RTC) adds the ability to program the drive to perform functions at specified times, and enables time stamping of events. The RTC is battery-backed. The battery recharges when the drive is powered.

#### Connection Details:

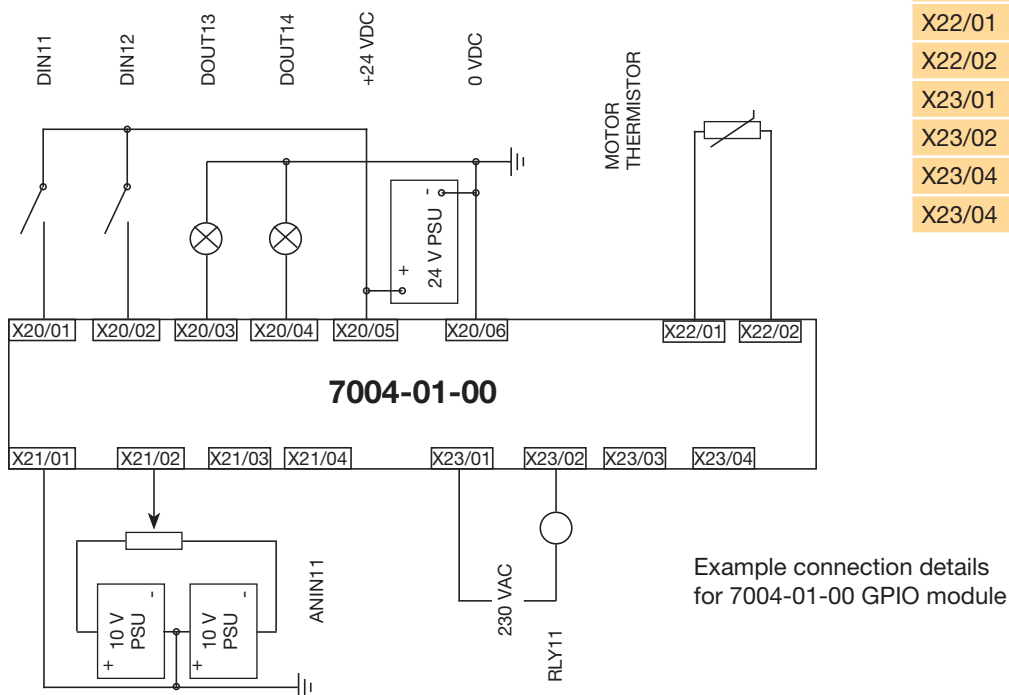

### 7004-02-00 - Motor Thermistor Input Module

Motor Thermistor Inputs	1x Motor thermistor input
Thermistor Compatibility	PTC, NTC, KTY
Thermistor Resistance Range	0...4.5 k $\Omega$



#### Description:

The isolated motor thermistor input module provides a means of monitoring motor temperature. By default the drive will trip if the motor exceeds a user-defined temperature threshold. All 7004 options with thermistor have the above same specification.

### 7004-05-00 - Resolver Feedback Module

Maximum Speed	70,000 rpm @ 12-bits
Carrier Output Signal	4-12V rms, 2 kHz - 20 kHz
Maximum Carrier Supply	70mA rms
Maximum Input Voltage	±24V pk differential
Accuracy	<±10 arc min
Resolution	12-16 bits
Inputs	Differential inputs Zin ~ 2.4 kΩ
Isolation	Not isolated



#### Description:

The resolver feedback module enables a range of resolvers to be connected to the AC30P/D allowing closed-loop control of PMAC motors. The 7004-05-00 is also equipped with a motor thermistor input. The option can also be used to provide a speed reference into any AC30 control module. The resolver module is fully programmable and a range of resolver accessory cables are available.

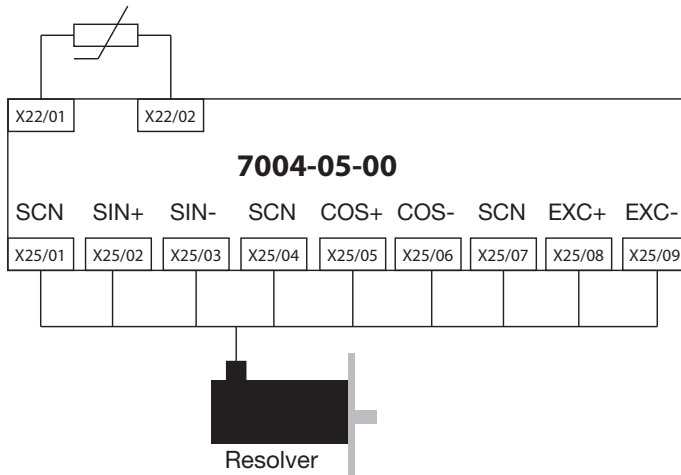

Terminal	Description
X25/01	Cable screen
X25/02	SIN+
X25/03	SIN-
X25/04	Cable screen
X25/05	COS+
X25/06	COS-
X25/07	Cable screen
X25/08	EXC+
X25/09	EXC-
X22/01	Motor thermistor
X22/02	Motor thermistor

### 7004-04-00 - Pulse Encoder Feedback Module

Maximum Input Frequency	250 kHz per channel
Supply Voltage Output	5 V, 12 V, 15 V, 24 V
Input Format	Quadrature, or Clock (inputs A & /A) and Direction (input B & /B)
Motor Thermistor Details	As 7004-02-00



#### Description:

The pulse encoder feedback module allows an incremental encoder to be connected to the AC30 allowing users to take full advantage of closed-loop vector control. The 7004-04-00 is also equipped with a motor thermistor input. The option can also be used to provide a speed reference into any AC30 control module.

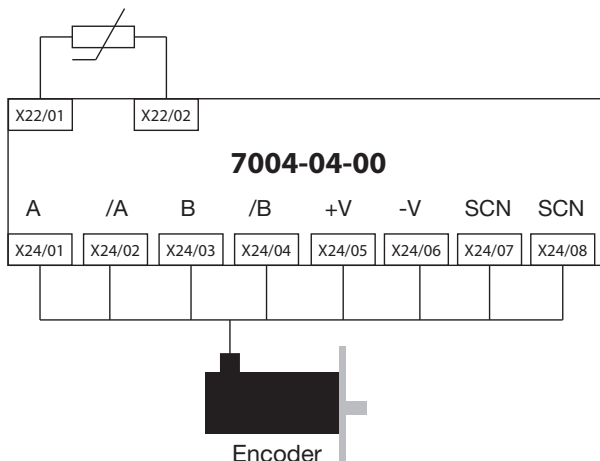

Terminal	Description
X24/01	Channel A
X24/02	Channel /A
X24/03	Channel B
X24/04	Channel /B
X24/05	Supply positive
X24/06	Supply negative
X24/07	Cable screen
X24/08	Cable screen
X22/01	Motor thermistor
X22/02	Motor thermistor

## Communication Interfaces

<b>7003-PB-00</b>	<b>PROFIBUS DP-V1 communication interface</b>
<b>Supported Protocols</b>	PROFIBUS-DP; Demand data and Data exchange
<b>Communication Speed</b>	Up to 12 Mbits/s; automatically detected
<b>Max. number of devices</b>	32 per segment, 126 total
<b>Supported Messages</b>	Up to 152 bytes cyclic I/O, 68 bytes class 1 and 2 acyclic data, 152 bytes configuration data. GSD file provided



<b>7003-CB-00</b>	<b>CANopen communication interface</b>
<b>Profile</b>	DS301 V4.02
<b>Communication Speed</b>	10 k, 20 k, 50 k, 125 k, 250 k, 500 k, 1 Mbits/s or automatically detected
<b>Max. number of devices</b>	127
<b>Supported Messages</b>	SDO, PDO, NMT, SYNC



<b>7003-PN-00</b>	<b>PROFINET I/O communication interface</b>
<b>Supported Protocols</b>	PROFINET I/O Real-Time (RT) Protocol
<b>Communication Speed</b>	100 Mbits/s full duplex
<b>Max. number of devices</b>	Virtually unlimited
<b>Supported Messages</b>	Up to 256 bytes of cyclic I/O in data in each direction



<b>7003-IP-00</b>	<b>Ethernet IP communication interface</b>
<b>Supported Protocols</b>	Ethernet IP
<b>Communication Speed</b>	10/100 Mbits/s full/half duplex
<b>Max. number of devices</b>	Virtually unlimited
<b>Supported Messages</b>	Up to 256 bytes of consumed data and 256 bytes of produced data, CIP parameter object support, Explicit messaging





## Communication Interfaces

<b>7003-RS-00</b>	<b>RS485 / Modbus RTU communication interface</b>
<b>Supported Protocols</b>	Modbus RTU
<b>Communication Speed</b>	1200 to 115200 bits/s
<b>Max. number of devices</b>	247
<b>Supported Messages</b>	Up to 256 bytes of cyclic I/O data in each direction



<b>7003-EC-00</b>	<b>EtherCAT communication interface</b>
<b>Supported Protocols</b>	CANopen over EtherCAT (CoE) DS301 compliant
<b>Communication Speed</b>	100 Mbits/s
<b>Max. number of devices</b>	65534
<b>Supported Messages</b>	SDO, PDO, NMT, SYNC



## Ancillary Parts

### Output Chokes

To reduce capacitive currents and prevent nuisance tripping in installations with longer cable runs, a choke may be fitted to the drives output in series with the motor.

Order Code	Motor Power Normal Duty [kW]	Choke Inductance [ $\mu$ ]	Current [ $A_{rms}$ ]
CO055931	1.1	2	7.5
	1.5		
	2.2		
	3.0		
CO057283	4.0	0.9	22
	5.5		
	7.5		
CO057284	11	0.45	33
	15		
CO057285	18	0.3	44
CO055193	22	50	70
	30		
CO055253	37	50	99
	45		
CO057960	55	50	243
CO0387886	75	50	360
	90		
	110		



Note 1: For output chokes over 75 kW please contact [ssdedcs@parker.com](mailto:ssdedcs@parker.com)

### EMC Filters

A range of custom designed optional EMC (Electromagnetic Compatibility) filters are available for use with Parker's range of drive products. They are used to help achieve conformance with the EMC directive BS EN 61800-3:2004- "Adjustable speed electrical power drive systems Part 3". These external filters offer C2 compliance to 25m and C1 compliance to 10m.

Order Code	Motor Power Normal Duty [kW]	Frame Size
CO501894	1.1	D
	1.5	D
	2.2	D
	3.0	D
	4.0	D
	5.5	D
	7.5	E
CO501895	11	E
	15	F
	18	F
CO465188U070	22	G
	30	G
CO467842U105	37	G
	45	H
CO467842U215	55	H
	75	H
	90	J
CO502672U320	110	J
	132	J
	160	K



Note 1: For EMC filters over 160 kW please contact [ssdedcs@parker.com](mailto:ssdedcs@parker.com)

## Braking Resistors

These resistor sets are designed for stopping the system at rated power. Rated for 10 seconds in a 100 seconds duty cycle. They are metal-clad resistors and should be mounted on a heatsink (back panel) and covered to prevent injury from burning.



### Brake resistor selection

Brake resistor assemblies must be rated to absorb both peak braking power during deceleration and the average power over the complete cycle.

$$\text{Peak braking power} = \frac{0.0055J \times (n_1^2 - n_2^2) (W)}{t_b}$$

$$\text{Average braking power } P_{av} = \frac{P_{pk} \times t_b}{t_c}$$

J: total inertia [kgm<sup>2</sup>]  
n<sub>1</sub>: initial speed [min<sup>-1</sup>]  
n<sub>2</sub>: final speed [min<sup>-1</sup>]  
t<sub>b</sub>: braking time [s]  
t<sub>c</sub>: cycle time [s]

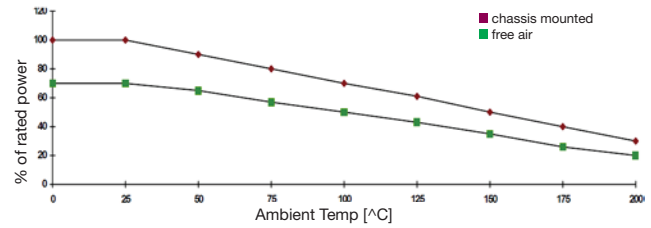

### Resistors above 500 W

Resistors above 500 W are available upon request :

- IP20 protection up to 3 kW
- IP13 protection between 4.2 and 9.8 kW

Model	Impedance [Ω]	Nom. Power [W]	Dimensions [mm]							
			L1	L2	L3	W	H	D	a	b
CZ467715	500	60	100	87	60	22	41	4.3	10	12
CZ467714	200	100	165	152	125	22	41	4.3	10	12
CZ389853	100	100	165	152	125	22	41	4.3	10	12
CZ467717	100	200	165	146	125	30	60	4.3	13	17
CZ463068	56	200	165	146	125	30	60	4.3	13	17
CZ388396	36	500	335	316	295	30	60	4.3	13	17
CZ467716	56	500	335	316	295	30	60	4.3	13	17

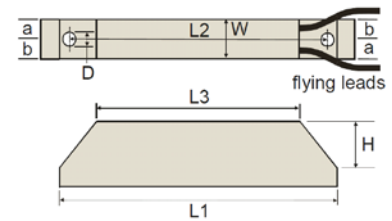

Overload 5 s: 500 %  
Overload 3 s : 833 %  
Overload 1 s: 2500 %

# AC30 Series Product Configuration

The AC30 is a modular product allowing users to select the correct power stack, control module and options to perfectly match their application. Simply select the required parts to build a product bill of materials that meets your requirements. Minimum required parts to build a complete drive is one control module and one power stack.

## Control Modules

<b>1</b>	<b>Device Family</b>
<b>30</b>	AC30 series control module only
<b>2</b>	<b>Performance</b>
<b>V</b>	Standard controller
<b>P</b>	Advanced controller
<b>D</b>	Advanced controller with dual encoder system option
<b>3</b>	<b>Graphical Keypad</b>
<b>1</b>	Blanking cover fitter
<b>2</b>	Graphical keypad fitted
<b>4</b>	<b>Environmental Coating</b>
<b>S</b>	Standard 3C3 coating
<b>8</b>	<b>Special Options</b>
<b>0000</b>	No special options



AC30V Control Module

AC30P Control Module

AC30D Control Module

## Accessories



### Graphical Keypad

Order Code	Description
7001-00-00	Graphical keypad for local or remote mounting
7001-01-00	Keypad blanking cover
LA501991U300	Keypad remote mounting kit (3 m cable and screws)

### Communication Interfaces



Order Code	Description
7003-PB-00	Profibus DPV1
7003-PN-00	Profinet IO
7003-CB-00	CANopen
7003-IP-00	Ethernet IP
7003-EC-00	EtherCAT
7003-RS-00	RS485/Modbus RTU

## I/O Options



Order Code	Description
7004-01-00	General purpose I/O module
7004-02-00	Motor thermistor input module
7004-04-00	Pulse encoder feedback module
7004-05-00	Resolver feedback module

## Power Stack Order Code

	1	2	3	4	5	6	7	8
Order example	710	4	D	0004	B	F	0	S

<b>1 Device Family</b>	<b>710</b> AC Power stack only (no control module)	<b>740</b> DC Power stack only (no control module)
<b>2 Voltage</b>	<b>4</b> 400 V nominal	
<b>3 Frame Size and Current Rating</b>	(normal / heavy duty)	
	<b>D0004</b> 1.1 kW / 0.75 kW	
	<b>D0006</b> 2.2 kW / 1.5 kW	
	<b>D0010</b> 4 kW / 3 kW	
	<b>D0012</b> 5.5 kW / 4 kW	
	<b>E0016</b> 7.5 kW / 5.5 kW	
	<b>E0023</b> 11 kW / 7.5 kW	
	<b>F0032</b> 15 kW / 11 kW	
	<b>F0038</b> 18.5 kW / 15 kW	
	<b>G0045</b> 22 kW / 18.5 kW	
	<b>G0060</b> 30 kW / 22 kW	
	<b>G0073</b> 37 kW / 30 kW	
	<b>H0087</b> 45 kW / 37 kW	
	<b>H0105</b> 55 kW / 45 kW	
	<b>H0145</b> 75 kW / 55 kW	
	<b>J0180</b> 90 kW / 75 kW	
	<b>J0205</b> 110 kW / 90 kW	
	<b>J0260</b> 132 kW / 110 kW	
	<b>K0315</b> 160 kW / 132 kW	
	<b>K0380</b> 200 kW / 160 kW	
	<b>K0440</b> 250 kW / 200 kW	
	<b>L0530</b> 280 kW / 250 kW	
	<b>L0590</b> 315 kW / 280 kW	
	<b>M0650</b> 355 kW / 315 kW	
	<b>M0700</b> 400 kW / 355 kW	
	<b>N0790</b> 450 kW / 400 kW	
<b>4 Brake Switch</b>	<b>B</b> Brake switch fitted (frames D to K)	<b>N</b> No brake switch fitted (frames L, M, N)
<b>5 EMC Filter <sup>(1)</sup></b>	<b>N</b> No filter fitted	<b>E</b> Category C3 filter fitted
	<b>F</b> Category C2 filter fitted	
<b>6 Graphical Keypad</b>	<b>0</b> No keypad fitted	
<b>7 Environmental Coating</b>	<b>S</b> Standard 3C3 coating	
<b>8 Special Options</b>	<b>0000</b> No special options	

<sup>(1)</sup> 710 device only :  
Category C3 filter fitted as standard for frames D to N only.  
Category C2 filter for frames D to H only. For other frames use external EMC filter



Order code 710...  
Power Stack Only

### EXAMPLE: AC30 Series Product Configuration

The below example shows a product configuration 'bill of materials' for a customer who requires control of a 45 kW motor. The application is to control an extruder, requiring closed-loop vector control with 110% overload and connection via profibus to a PLC. Parker recommends the AC30P control module for this application.

Part Number	Quantity	Description
30P-2S-0000	1	Control module with graphical keypad and standard coating
7003-PB-00	1	Profibus option module
7004-04-00	1	Pulse encoder feedback card
710-4H-0087-BE-0S-0000	1	45 kW AC input power stack with brake switch and C3 EMC filter

## AC30V Product Order Code

The AC30V is designed for simple, single-axis applications. To allow customers to quickly select the complete drive to match their application, we have made the AC30V available to order under a single product number. This product code includes one power stack and one control module. Option modules must still be ordered separately.

	1	2	3	4	5	6	7	8	
Order example	<b>31V</b>	<b>4</b>	<b>D</b>	<b>0004</b>	<b>B</b>	<b>F</b>	<b>2</b>	<b>S</b>	<b>0000</b>

<b>1 Device Family</b>	<b>31V</b> AC30 Series complete drive
<b>2 Voltage</b>	<b>4</b> 400 V nominal
<b>3 Frame Size and Current Rating</b>	(normal / heavy duty)
<b>D0004</b>	1.1 kW / 0.75 kW
<b>D0006</b>	2.2 kW / 1.5 kW
<b>D0010</b>	4 kW / 3 kW
<b>D0012</b>	5.5 kW / 4 kW
<b>E0016</b>	7.5 kW / 5.5 kW
<b>E0023</b>	11 kW / 7.5 kW
<b>F0032</b>	15 kW / 11 kW
<b>F0038</b>	18.5 kW / 15 kW
<b>G0045</b>	22 kW / 18.5 kW
<b>G0060</b>	30 kW / 22 kW
<b>G0073</b>	37 kW / 30 kW
<b>H0087</b>	45 kW / 37 kW
<b>H0105</b>	55 kW / 45 kW
<b>H0145</b>	75 kW / 55 kW
<b>J0180</b>	90 kW / 75 kW
<b>J0205</b>	110 kW / 90 kW
<b>J0260</b>	132 kW / 110 kW

<b>4 Brake Switch <sup>(1)</sup></b>	<b>B</b> Brake switch fitted (standard)
<b>5 EMC Filter <sup>(2)</sup></b>	<b>N</b> No filter fitted
	<b>E</b> Category C3 filter fitted (standard)
	<b>F</b> Category C2 filter fitted
<b>6 Graphical Keypad</b>	<b>2</b> Graphical keypad fitted
<b>7 Environmental Coating <sup>(3)</sup></b>	<b>S</b> Standard 3C3 coating
<b>8 Special Options</b>	<b>0000</b> No special options

<sup>(1)</sup> Drives include brake switch as standard. For non-brake options please contact [ssdedcs@parker.com](mailto:ssdedcs@parker.com)

<sup>(2)</sup> The choice of filter should be determined by the environment in which the drive will be installed as defined in IEC/EN61800-3 C2 = domestic & commercial, C3 = industrial

<sup>(3)</sup> AC30 is conformally coated as standard for use in environments class 3C3 and 3C4 for Hydrogen Sulphide gas. It is also compliant to both classes 3C1 (rural) and 3C2 (urban) for all nine substances defined in table 4 in EN60271-3-3 C2 filter only offered on frames D-H. For other frames use external EMC filter

## AC30 DC Supply Unit Product Order Code

The AC30 series supply units offer four quadrant (supply and regeneration) DC power for system applications.

	1	2	3	4	5	6
Order example	380	5	R 0094	N	E	0000

<b>1</b>	<b>Device Family</b>
380	AC30 Series 4 Quadrant Supply
<b>2</b>	<b>Voltage</b>
5	400 V - 500 V nominal
<b>3</b>	<b>Frame Size and Current Rating</b>
Output Driving Current Rating / Nominal Driving Power at 500V	
R0094	94A / 60 kW
R0157	157A / 100 kW
S0251	251A / 160 kW
S0394	394A / 250 kW
S0536	536A / 340 kW

<b>4</b>	<b>Brake Switch</b>
N	No brake switch fitted (standard)
<b>5</b>	<b>EMC Filter</b>
E	Category C3 filter fitted (standard)
<b>6</b>	<b>Special Options</b>
0000	No special options

### Accessories

#### Harmonic Filter

Supply unit input filter required to achieve reduced harmonics.

Order Code	Description
CO3705060	60 kW Harmonic Filter
CO3705100	100 kW Harmonic Filter
CO3705160	160 kW Harmonic Filter
CO3705250	250 kW Harmonic Filter
CO3705350	350 kW Harmonic Filter







# Parker's Motion & Control Technologies

At Parker, we're guided by a relentless drive to help our customers become more productive and achieve higher levels of profitability by engineering the best systems for their requirements. It means looking at customer applications from many angles to find new ways to create value. Whatever the motion and control technology need, Parker has the experience, breadth of product and global reach to consistently deliver. No company knows more about motion and control technology than Parker. For further info call 00800 27 27 5374



## Aerospace

### Key Markets

Aftermarket services  
Commercial transports  
Engines  
General & business aviation  
Helicopters  
Launch vehicles  
Military aircraft  
Missiles  
Power generation  
Regional transports  
Unmanned aerial vehicles

### Key Products

Control systems & actuation products  
Engine systems & components  
Fluid conveyance systems & components  
Fluid metering, delivery & atomization devices  
Fuel systems & components  
Fuel tank inerting systems  
Hydraulic systems & components  
Thermal management  
Wheels & brakes



## Climate Control

### Key Markets

Agriculture  
Air conditioning  
Construction Machinery  
Food & beverage  
Industrial machinery  
Life sciences  
Oil & gas  
Precision cooling  
Process  
Refrigeration  
Transportation

### Key Products

Accumulators  
Advanced actuators  
CO<sub>2</sub> controls  
Electronic controllers  
Filter driers  
Hand shut-off valves  
Heat exchangers  
Hose & fittings  
Pressure regulating valves  
Refrigerant distributors  
Safety relief valves  
Smart pumps  
Solenoid valves  
Thermostatic expansion valves



## Electromechanical

### Key Markets

Aerospace  
Factory automation  
Life science & medical  
Machine tools  
Packaging machinery  
Paper machinery  
Plastics machinery & converting  
Primary metals  
Semiconductor & electronics  
Textile  
Wire & cable

### Key Products

AC/DC drives & systems  
Electric actuators, gantry robots & slides  
Electrohydraulic actuation systems  
Electromechanical actuation systems  
Human machine interface  
Linear motors  
Stepper motors, servo motors, drives & controls  
Structural extrusions



## Filtration

### Key Markets

Aerospace  
Food & beverage  
Industrial plant & equipment  
Life sciences  
Marine  
Mobile equipment  
Oil & gas  
Power generation & renewable energy  
Process  
Transportation  
Water Purification

### Key Products

Analytical gas generators  
Compressed air filters & dryers  
Engine air, coolant, fuel & oil filtration systems  
Fluid condition monitoring systems  
Hydraulic & lubrication filters  
Hydrogen, nitrogen & zero air generators  
Instrumentation filters  
Membrane & fiber filters  
Microfiltration  
Sterile air filtration  
Water desalination & purification filters & systems



## Fluid & Gas Handling

### Key Markets

Aerial lift  
Agriculture  
Bulk chemical handling  
Construction machinery  
Food & beverage  
Fuel & gas delivery  
Industrial machinery  
Life sciences  
Marine  
Mining  
Mobile  
Oil & gas  
Renewable energy  
Transportation

### Key Products

Check valves  
Connectors for low pressure fluid conveyance  
Deep sea umbilicals  
Diagnostic equipment  
Hose couplings  
Industrial hose  
Mooring systems & power cables  
PTFE hose & tubing  
Quick couplings  
Rubber & thermoplastic hose  
Tube fittings & adapters  
Tubing & plastic fittings



## Hydraulics

### Key Markets

Aerial lift  
Agriculture  
Alternative energy  
Construction machinery  
Forestry  
Industrial machinery  
Machine tools  
Marine  
Material handling  
Mining  
Oil & gas  
Power generation  
Refuse vehicles  
Renewable energy  
Truck hydraulics  
Turf equipment

### Key Products

Accumulators  
Cartridge valves  
Electrohydraulic actuators  
Human machine interfaces  
Hybrid drives  
Hydraulic cylinders  
Hydraulic motors & pumps  
Hydraulic systems  
Hydraulic valves & controls  
Hydrostatic steering  
Integrated hydraulic circuits  
Power take-offs  
Power units  
Rotary actuators  
Sensors



## Pneumatics

### Key Markets

Aerospace  
Conveyor & material handling  
Factory automation  
Life science & medical  
Machine tools  
Packaging machinery  
Transportation & automotive

### Key Products

Air preparation  
Brass fittings & valves  
Manifolds  
Pneumatic accessories  
Pneumatic actuators & grippers  
Pneumatic valves & controls  
Quick disconnects  
Rotary actuators  
Rubber & thermoplastic hose & couplings  
Structural extrusions  
Thermoplastic tubing & fittings  
Vacuum generators, cups & sensors



## Process Control

### Key Markets

Alternative fuels  
Biopharmaceuticals  
Chemical & refining  
Food & beverage  
Marine & shipbuilding  
Medical & dental  
Microelectronics  
Nuclear Power  
Offshore oil exploration  
Oil & gas  
Pharmaceuticals  
Power generation  
Pulp & paper  
Steel  
Water/wastewater

### Key Products

Analytical Instruments  
Analytical sample conditioning products & systems  
Chemical injection fittings & valves  
Fluoropolymer chemical delivery fittings, valves & pumps  
High purity gas delivery fittings, valves, regulators & digital flow controllers  
Industrial mass flow meters/ controllers  
Permanent no-weld tube fittings  
Precision industrial regulators & flow controllers  
Process control double block & bleeds  
Process control fittings, valves, regulators & manifold valves



## Sealing & Shielding

### Key Markets

Aerospace  
Chemical processing  
Consumer  
Fluid power  
General industrial  
Information technology  
Life sciences  
Microelectronics  
Military  
Oil & gas  
Power generation  
Renewable energy  
Telecommunications  
Transportation

### Key Products

Dynamic seals  
Elastomeric o-rings  
Electro-medical instrument design & assembly  
EMI shielding  
Extruded & precision-cut, fabricated elastomeric seals  
High temperature metal seals  
Homogeneous & inserted elastomeric shapes  
Medical device fabrication & assembly  
Metal & plastic retained composite seals  
Shielded optical windows  
Silicone tubing & extrusions  
Thermal management  
Vibration dampening

# Parker Worldwide

## Europe, Middle East, Africa

**AE – United Arab Emirates, Dubai**  
Tel: +971 4 8127100  
parker.me@parker.com

**AT – Austria, Wiener Neustadt**  
Tel: +43 (0)2622 23501-0  
parker.austria@parker.com

**AT – Eastern Europe, Wiener Neustadt**  
Tel: +43 (0)2622 23501 900  
parker.easteurope@parker.com

**AZ – Azerbaijan, Baku**  
Tel: +994 50 2233 458  
parker.azerbaijan@parker.com

**BE/LU – Belgium, Nivelles**  
Tel: +32 (0)67 280 900  
parker.belgium@parker.com

**BG – Bulgaria, Sofia**  
Tel: +359 2 980 1344  
parker.bulgaria@parker.com

**BY – Belarus, Minsk**  
Tel: +48 (0)22 573 24 00  
parker.poland@parker.com

**CH – Switzerland, Etoy**  
Tel: +41 (0)21 821 87 00  
parker.switzerland@parker.com

**CZ – Czech Republic, Klecany**  
Tel: +420 284 083 111  
parker.czechrepublic@parker.com

**DE – Germany, Kaarst**  
Tel: +49 (0)2131 4016 0  
parker.germany@parker.com

**DK – Denmark, Ballerup**  
Tel: +45 43 56 04 00  
parker.denmark@parker.com

**ES – Spain, Madrid**  
Tel: +34 902 330 001  
parker.spain@parker.com

**FI – Finland, Vantaa**  
Tel: +358 (0)20 753 2500  
parker.finland@parker.com

**FR – France, Contamine s/Arve**  
Tel: +33 (0)4 50 25 80 25  
parker.france@parker.com

**GR – Greece, Athens**  
Tel: +30 210 933 6450  
parker.greece@parker.com

**HU – Hungary, Budaörs**  
Tel: +36 23 885 470  
parker.hungary@parker.com

**IE – Ireland, Dublin**  
Tel: +353 (0)1 466 6370  
parker.ireland@parker.com

**IL – Israel**  
Tel: +39 02 45 19 21  
parker.israel@parker.com

**IT – Italy, Corsico (MI)**  
Tel: +39 02 45 19 21  
parker.italy@parker.com

**KZ – Kazakhstan, Almaty**  
Tel: +7 7273 561 000  
parker.easteurope@parker.com

**NL – The Netherlands, Oldenzaal**  
Tel: +31 (0)541 585 000  
parker.nl@parker.com

**NO – Norway, Asker**  
Tel: +47 66 75 34 00  
parker.norway@parker.com

**PL – Poland, Warsaw**  
Tel: +48 (0)22 573 24 00  
parker.poland@parker.com

**PT – Portugal**  
Tel: +351 22 999 7360  
parker.portugal@parker.com

**RO – Romania, Bucharest**  
Tel: +40 21 252 1382  
parker.romania@parker.com

**RU – Russia, Moscow**  
Tel: +7 495 645-2156  
parker.russia@parker.com

**SE – Sweden, Spånga**  
Tel: +46 (0)8 59 79 50 00  
parker.sweden@parker.com

**SK – Slovakia, Banská Bystrica**  
Tel: +421 484 162 252  
parker.slovakia@parker.com

**SL – Slovenia, Novo Mesto**  
Tel: +386 7 337 6650  
parker.slovenia@parker.com

**TR – Turkey, Istanbul**  
Tel: +90 216 4997081  
parker.turkey@parker.com

**UA – Ukraine, Kiev**  
Tel: +48 (0)22 573 24 00  
parker.poland@parker.com

**UK – United Kingdom, Warwick**  
Tel: +44 (0)1926 317 878  
parker.uk@parker.com

**ZA – South Africa, Kempton Park**  
Tel: +27 (0)11 961 0700  
parker.southafrica@parker.com

## North America

**CA – Canada, Milton, Ontario**  
Tel: +1 905 693 3000

**US – USA, Cleveland**  
Tel: +1 216 896 3000

## Asia Pacific

**AU – Australia, Castle Hill**  
Tel: +61 (0)2-9634 7777

**CN – China, Shanghai**  
Tel: +86 21 2899 5000

**HK – Hong Kong**  
Tel: +852 2428 8008

**IN – India, Mumbai**  
Tel: +91 22 6513 7081-85

**JP – Japan, Tokyo**  
Tel: +81 (0)3 6408 3901

**KR – South Korea, Seoul**  
Tel: +82 2 559 0400

**MY – Malaysia, Shah Alam**  
Tel: +60 3 7849 0800

**NZ – New Zealand, Mt Wellington**  
Tel: +64 9 574 1744

**SG – Singapore**  
Tel: +65 6887 6300

**TH – Thailand, Bangkok**  
Tel: +662 186 7000

**TW – Taiwan, Taipei**  
Tel: +886 2 2298 8987

## South America

**AR – Argentina, Buenos Aires**  
Tel: +54 3327 44 4129

**BR – Brazil, Sao Jose dos Campos**  
Tel: +55 800 727 5374

**CL – Chile, Santiago**  
Tel: +56 2 623 1216

**MX – Mexico, Toluca**  
Tel: +52 72 2275 4200



## EMEA Product Information Centre

Free phone: 00 800 27 27 5374

(from AT, BE, CH, CZ, DE, DK, EE, ES, FI, FR, IE, IL, IS, IT, LU, MT, NL, NO, PL, PT, RU, SE, SK, UK, ZA)

## US Product Information Centre

Toll-free number: 1-800-27 27 537

www.parker.com