

XtraforsEx

Explosion-proof Servomotors



Features

- ExdIIC certified ATEX (according to standard EN 60079)
- DC and AC brushless series
- Axial magnetic flux
- Low cogging torque

Power

- MS series: Rated torque from 0.60 to 8.19 Nm
- MA series: Rated torque from 1.23 to 13.00 Nm

Executions

- Wide range of standard models
- Customized versions
- Sizes 149.5 to 188.6 mm

XtraforsEx, explosion-proof Servomotors

The XtraforsEx series are axial airgap AC and DC servomotors housed in an flame-proof enclosure. The motors are ATEX and CE compliant Zone 1 and 21, Gas group IIC (Hydrogen).

Technical data

		DC Servomotors						AC Servomotors				
		MS-2	MS-4	MS-6	MS-8	MS-12	MS-22	MA-3	MA-6	MA-10	MA-20	MA-30
Rated torque	[Nm]	0.60	1.26	1.83	2.56	3.95	8.19	1.23	3.47	5.40	7.70	13.00
Rated speed	[rpm]	3000	3000	3000	3000	3000	3000	5330	3560	3650	3070	3180
Rated current	[ADC]	6.5	7.8	10.7	10.7	14.0	16.0	2.05	3.86	6.00	7.40	13.00
Rated voltage	[VDC]	39.4	67.0	67.8	89.7	106.7	181.0					
Peak speed	[rpm]	7000	6000	6000	5000	4500	4000					
Peak speed@230VAC	[rpm]							6950	4170	4170	3470	3470
Peak speed@400VAC	[rpm]							9000	6000	6000	6000	6000

Torque curves

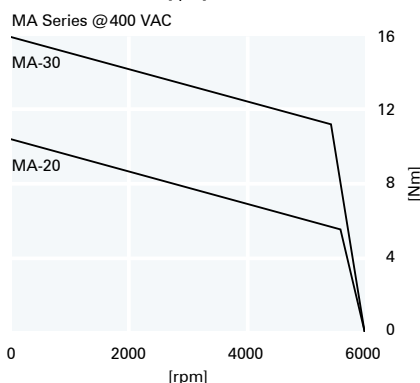
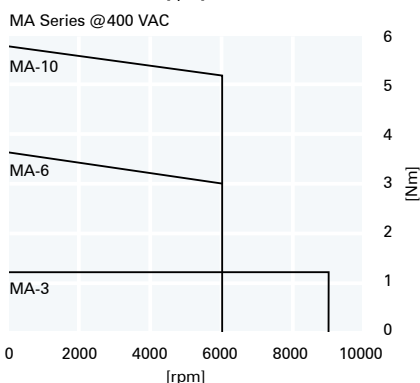
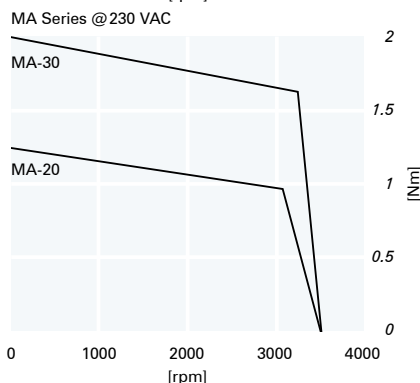
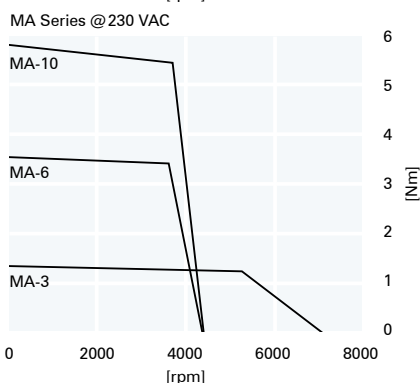
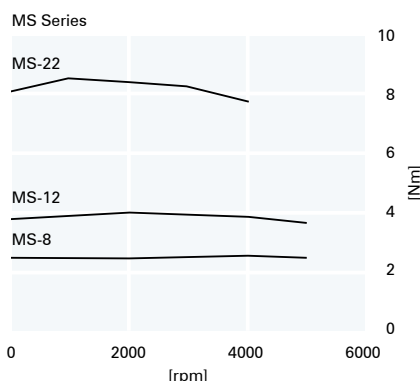
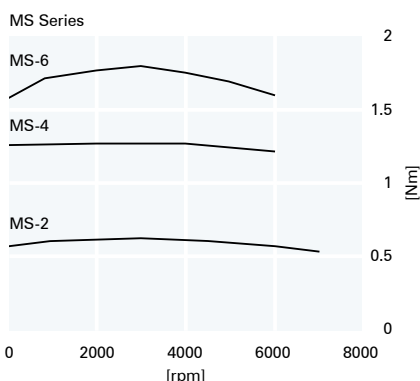

Standard version

- Shaft with keyway
- Round flange (B14)
- Cable connection

AC series

- Resolver feedback
- NTC thermal sensor

Options

- Brake
- Shaft without keyway
- Square flange (B5)

AC series

- Encoder feedback with hall sensors
- Confectioned power and feedback cables
- Low backlash gearboxes adaptation

DC series

- Tachogenerator

Customized versions

- Output shaft
- Flange

Mechanical dimensions

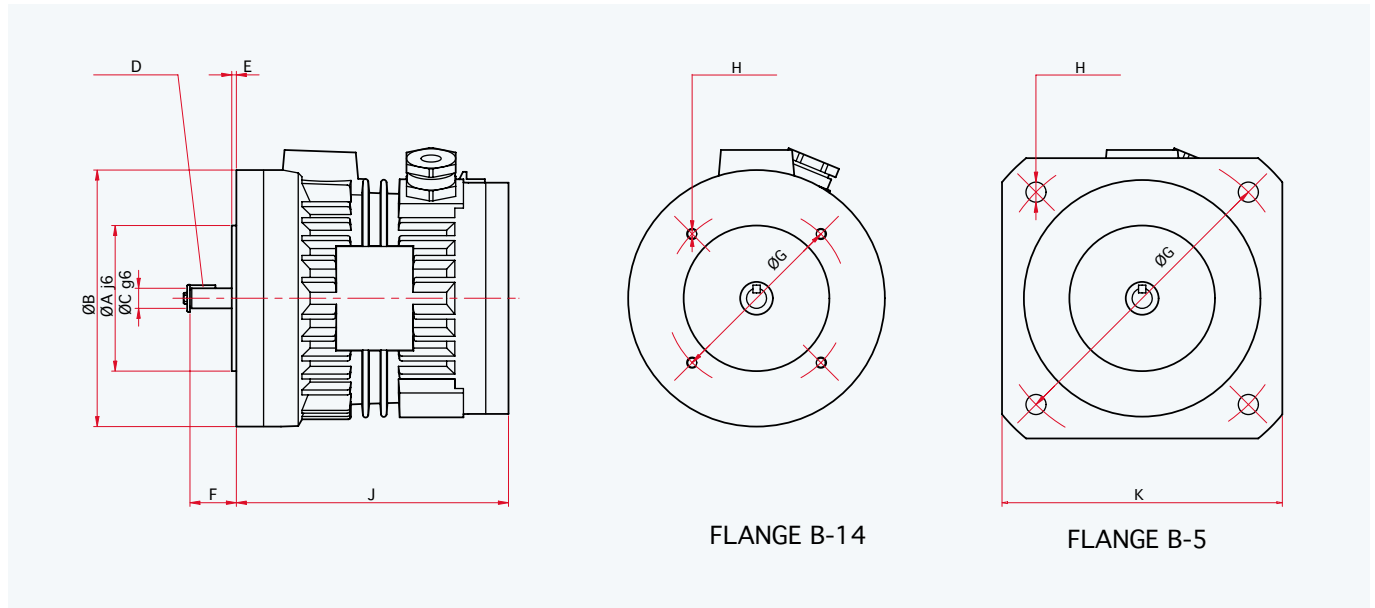

Dimensions [mm]		Flange	MS-2	MS-4, -6, -8	MS-12, -22	MA-3	MA-6, -10	MA-20, -30
A Ø	j6	B14	80	95	180	80	95	180
		B5	130	180	250	130	180	250
B Ø			141	201	262	141	201	262
C Ø	g6		11	14	24	11	14	24
D	DIN 6885		A4x4x14	A5x5x20	A8x7x32	A4x4x14	A5x5x20	A8x7x32
E			2.5	2.0	3.5	2.5	2.0	3.5
F			25.5	30.0	50.0	25.5	30.0	50.0
G Ø	±0,1	B14	100	115	215	100	115	215
		B5	165	215	300	165	215	300
H	Ø	B14	4xM6x8	4xM6x10	4xM12x14	4xM6x8	4xM6x10	4xM12x14
		B5	4xØ11	4xØ11	4xØ18	4xØ11	4xØ11	4xØ18
J			149.5	159.5	188.6	149.5	159.5	188.6
K		B5	154 ± 1	201 ± 1	284 ± 1.5	154 ± 1	201 ± 1	284 ± 1.5

Brakes

		MS-2	MS-4, -6, -8	MS-12	MS-22	MA-3	MA-6, -10	MA-20, -30
Torque	[Nm]	1.2	2.5	5.0	12.0	1.0	4.0	8.0
Tension	[VDC]			24 (+6% - 10%)				24 (+6% - 10%)

Tachogenerators

Type		D40	D40	D40	D26			
Tension	[V/krpm]				10 ± 5%			

Addresses

Switzerland

Infranor SA

Place de la Gare 5
CH-1296 Coppet
Phone +41 22 960 70 70
Fax +41 22 960 70 80
www.infranor.ch
infranor@infranor.ch

Infranor AG

Schaffhauserstrasse 418
CH-8050 Zürich
Phone +41 44 308 50 00
Fax +41 44 308 50 09
www.infranor.ch
infranor@infranor.ch

Germany

Infranor GmbH

Donaustrasse 19a
D-63452 Hanau
Phone +49 6181 18012 0
Fax +49 6181 18012 90
www.infranor.de
info@infranor.de

France

Infranor SAS

3, avenue Louis Delage
F-91310 Linas
Phone +33 1 69 633 515
Fax +33 1 69 633 516
www.infranor-france.com
infranor@infranorfrance.com

Spain

Infranor Spain SL

Occitània, 24
E-08911 Badalona
(Barcelona)
Phone +34 93 460 16 31
Fax +34 93 399 96 08
www.infranor.es
infranor@infranor.es

Benelux

Infranor B.V.

Albert Einsteinstraat 6
NL-3261 LP Oud-Beijerland
Phone +31 186 610 155
Fax +31 186 614 535
www.infranor.nl
info@infranor.nl

England

Infranor Ltd.

Unit 60A, Smithbrook Kilns
Cranleigh
UK-Surrey GU6 8JJ
Phone +44 1483 274 887
Fax +44 1483 276 037
www.infranor.ltd.uk
sales@infranor.ltd.uk

USA

Infranor, Inc.

299 Ballardvale Street Suite 4
USA-Wilmington, MA 01887
Phone +1 978 988 9002
Fax +1 978 988 9112
www.infranorusa.com
info@infranorusa.com

China

Infranor Motion Control Technology (Shanghai) Co., Ltd.

Room 4E, Building A4
No. 700 Yishan Rd
CN-200233 Shanghai
Phone +86 21 6440 1095
Fax +86 21 6440 1095
www.infranor.cn
info@infranor.cn



The Infranor Group

Infranor creates added value for its customers by providing tailor-made motion solutions.

Based on strong working relationships, Infranor offers extensive market know-how, comprehensive engineering skills and a wide range of high-quality products leading to productivity gains and therefore to comparative advantages for its customers in their respective markets.

The Infranor Brand

The Infranor Brand is a synonym for:

- Excellence
- Cooperation
- Added value