

# Xtrafors Washdown AC Servomotors



## Features

- Smooth edges
- Stainless steel housing and shaft
- Protection IP 67

## Power

- Torque from 1.28 to 4.75 Nm

## Executions

- Wide range of standard models
- Customized versions
- Sizes 134 to 235 mm

# XtraforsWashdown, AC Servomotors

The housings of these synchronous servomotors are manufactured from stainless steel with a plain cylindrical shape. The smooth outline makes them particularly well suited for applications in food, medical, pharmaceutical and chemical industries as well as in other similar industrial branches.

## Technical data

	Rated torque [Nm]	Rated speed [rpm]	Rated current [Arms]	Peak speed Winding A		Peak speed Winding 4	
				@230VAC [rpm]	@400VAC [rpm]	Rated current [Arms]	@400VAC [rpm]
<b>BF-82</b>	1.28	6700	2.67	7450	-	1.60	7900
<b>BF-83</b>	1.70	4650	2.46	5170	8520	0.15	5100
<b>BF-122</b>	3.90	4000	4.70	4350	7550	2.57	4100
<b>BF-124</b>	4.75	4210	5.72	4350	7500	3.28	4300

## Torque curves

Winding A @230VAC

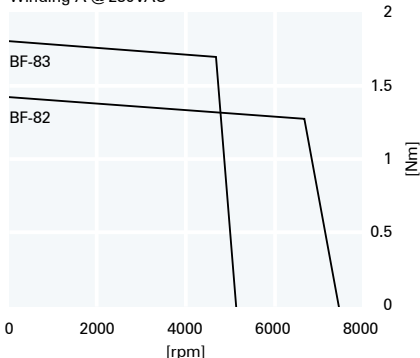

Winding A @230VAC

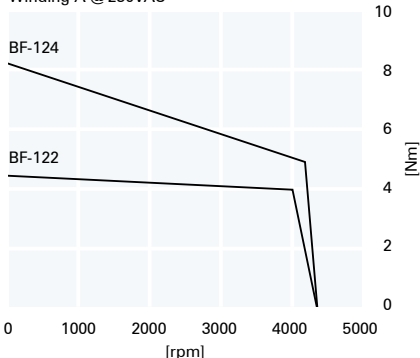

Winding A @400VAC

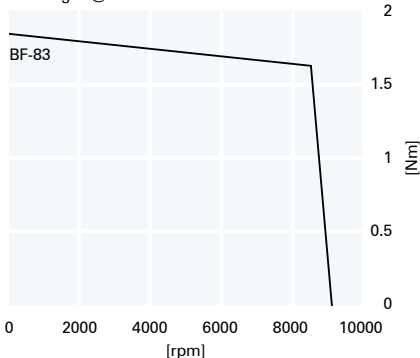

Winding A @400VAC

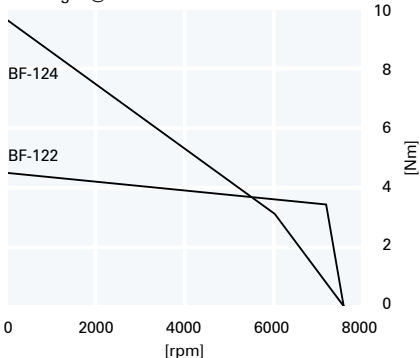

Winding 4 @400VAC

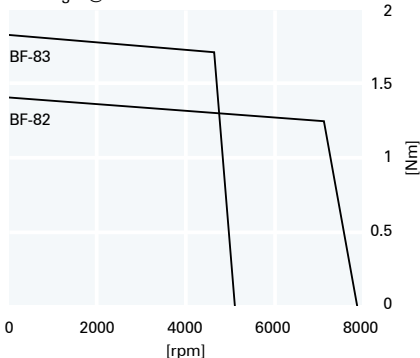

Winding 4 @400VAC

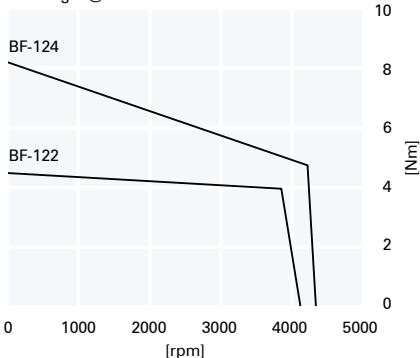

## Standard version

- Resolver feedback
- Stainless steel housing
- Stainless steel shaft
- Protection IP 67
- Direct cable output
- NTC thermal sensor
- 230VAC or 400VAC winding

## Options

- Various types of incremental encoders  
SinCos encoders, Hyperface, EndDat
- Shaft without keyway
- PTC thermal sensor

## Customized versions

- Winding

## Mechanical dimensions

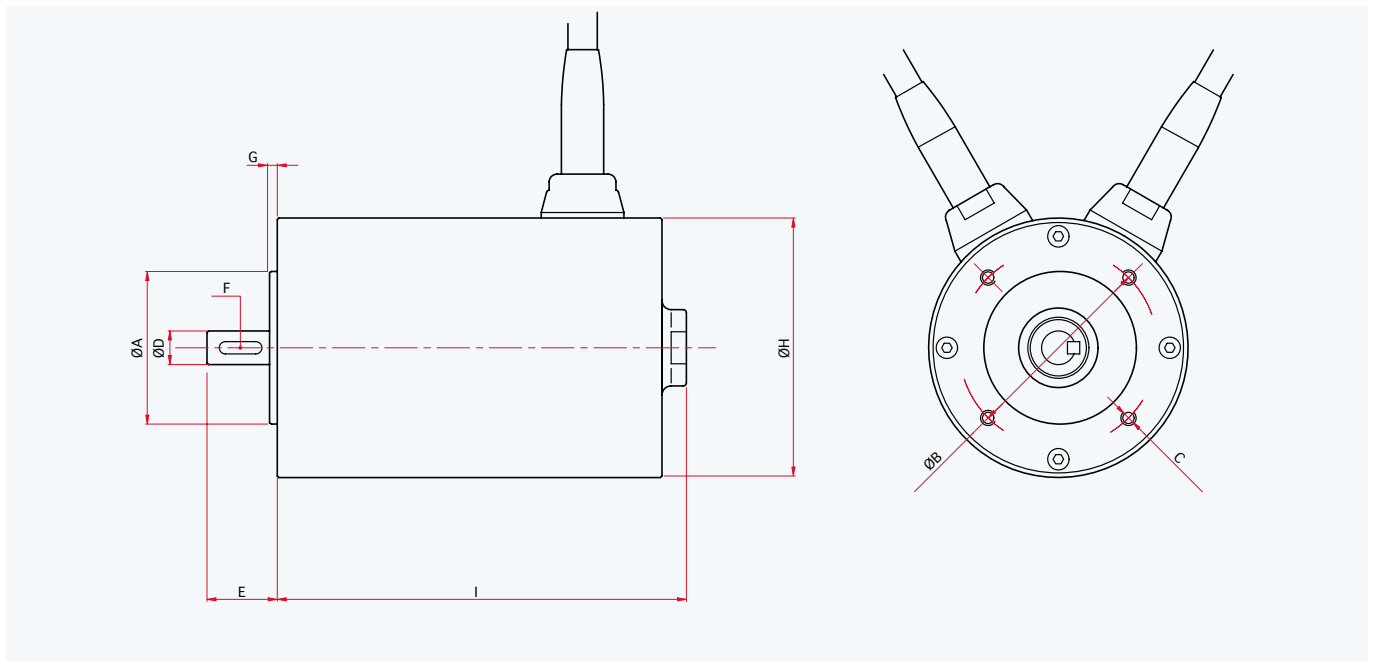

Dimensions [mm]		BF-82	BF-83	BF-122	BF-124
A Ø	j5	50	50	80	80
B Ø		65	65	100	100
C		4xM5	4xM5	4xM6	4xM6
D Ø	k6	11	11	19	19
E		23	23	40	40
F		A4x4x14	A4x4x14	A6x6x30	A6x6x30
G		2.5	2.5	3.0	3.0
H Ø		85	85	125	125
I	without brake	134	152	185	235
	with brake	158	175	206	256

## Brakes

Torque	[Nm]	1.5	3.0	8.0	12.0
Tension	[VDC]				24 (+6% - 10%)

# Addresses

## Switzerland

### Infranor SA

Place de la Gare 5  
CH-1296 Coppet  
Phone +41 22 960 70 70  
Fax +41 22 960 70 80  
www.infranor.ch  
infranor@infranor.ch

### Infranor AG

Schaffhauserstrasse 418  
CH-8050 Zürich  
Phone +41 44 308 50 00  
Fax +41 44 308 50 09  
www.infranor.ch  
infranor@infranor.ch

## Germany

### Infranor GmbH

Donaustrasse 19a  
D-63452 Hanau  
Phone +49 6181 18012 0  
Fax +49 6181 18012 90  
www.infranor.de  
info@infranor.de

## France

### Infranor SAS

3, avenue Louis Delage  
F-91310 Linas  
Phone +33 1 69 633 515  
Fax +33 1 69 633 516  
www.infranor-france.com  
infranor@infranorfrance.com

## Spain

### Infranor Spain SL

Occitània, 24  
E-08911 Badalona  
(Barcelona)  
Phone +34 93 460 16 31  
Fax +34 93 399 96 08  
www.infranor.es  
infranor@infranor.es

## Benelux

### Infranor B.V.

Albert Einsteinstraat 6  
NL-3261 LP Oud-Beijerland  
Phone +31 186 610 155  
Fax +31 186 614 535  
www.infranor.nl  
info@infranor.nl

## England

### Infranor Ltd.

Unit 60A, Smithbrook Kilns  
Cranleigh  
UK-Surrey GU6 8JJ  
Phone +44 1483 274 887  
Fax +44 1483 276 037  
www.infranor.ltd.uk  
sales@infranor.ltd.uk

## USA

### Infranor, Inc.

299 Ballardvale Street Suite 4  
USA-Wilmington, MA 01887  
Phone +1 978 988 9002  
Fax +1 978 988 9112  
www.infranorusa.com  
info@infranorusa.com

## China

### Infranor Motion Control Technology (Shanghai) Co., Ltd.

Room 4E, Building A4  
No. 700 Yishan Rd  
CN-200233 Shanghai  
Phone +86 21 6440 1095  
Fax +86 21 6440 1095  
www.infranor.cn  
info@infranor.cn

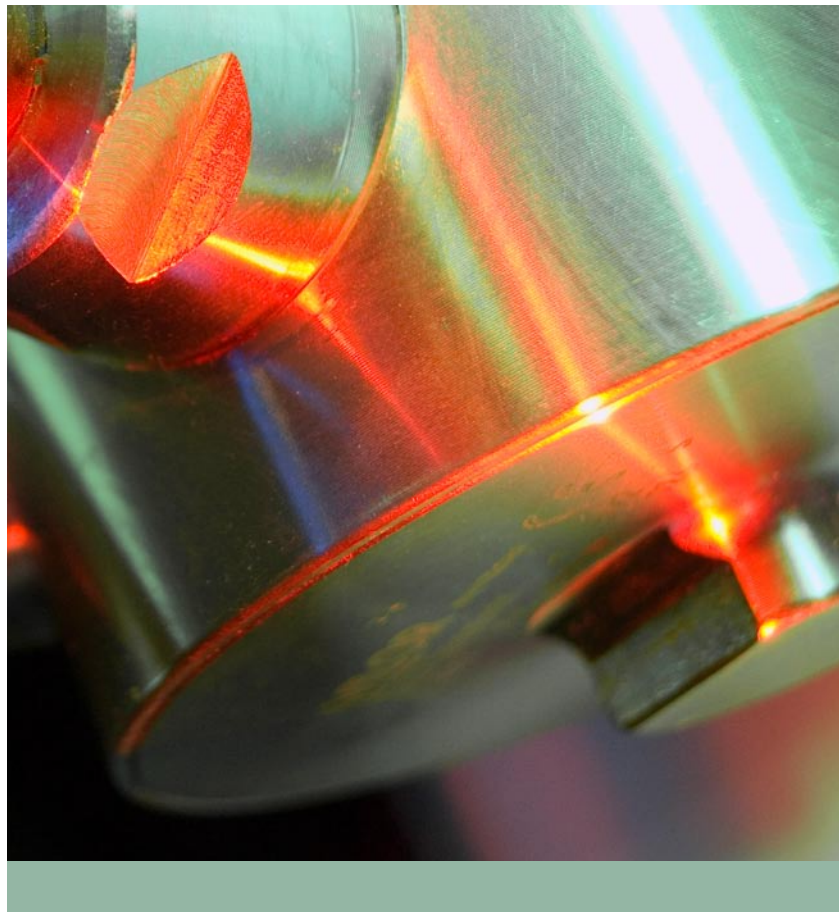

## The Infranor Group

Infranor creates added value for its customers by providing tailor-made motion solutions.

Based on strong working relationships, Infranor offers extensive market know-how, comprehensive engineering skills and a wide range of high-quality products leading to productivity gains and therefore to comparative advantages for its customers in their respective markets.

## The Infranor Brand

The Infranor Brand is a synonym for:

- Excellence
- Cooperation
- Added value